



United Pacific

TRUCK

2020 New Product Collection



HOW TO ORDER

To order from United Pacific Industries, you must be an authorized dealer, distributor or OEM.

If you are not authorized to stock and sell United Pacific products, you must order through an authorized dealer.

Please call 800.790.6988 for more information.

CONTACT US

 8 am - 4:30 pm PST

 Sales@upauto.com

 800.790.6988 / 562.421.3888

 UPauto.com

 888.986.5988

 3788 E. Conant St., Long Beach, CA 90808

QUALITY

With over 30 years of experience in the automotive aftermarket industry, United Pacific Industries understands the rigors and stresses that our products are subjected to on the road. It is our mission to provide our customers with products of superior quality and reliability. In achieving this goal, United Pacific only partners with manufacturing facilities that conforms to our quality control requirements and standards. Our manufacturing partners meet or exceed ISO-9001 requirements. In addition, United Pacific's manufacturing partners must be equipped on site to perform the following quality assurance tests and maintain a track record of consistent quality and low product failure rate.

- Photometric Test
- Pull Force Test
- Rain Test
- Salt Spray Test
- Shock Test
- Temperature Test
- Humidity Test
- Vibration Test

Furthermore, our internal quality control structure allows us to function as the final quality control station prior to shipping. With the assistance of 3D computer technology, United Pacific can adhere to strict quality control standards during prototype creation and the production process. Our engineers and technicians perform a battery of tests to ensure that our products meet the demands of today's drivers and our goal to be first in quality.

INNOVATION

Known as the leader in innovation, United Pacific is dedicated to be the first to bring new and exciting products to the market. United Pacific's global expertise allows us to search the globe for new ideas and concepts. Not only do we search the globe for new products, United Pacific invest a significant amount of resources into our own research and development efforts. With the assistance of advance 3D scanning technology, our engineers and designers can acquire accurate and precise data in seconds. The 3D data allows United Pacific to verify designs, perform quality assurance tests, and reverse engineer with unprecedented speed and accuracy. Digital inspection contributes to the early detection of shape problems, provides rapid feedback on design, and eliminates unnecessary work in downstream processes. Our rapid prototyping facility permits us to have a concept-to-shelf time of less than 5 months. In addition, United Pacific's 3D printing capabilities permit our designers to have physical models of their design concepts in hours. The physical models allow our designers and marketing staff to evaluate and test the viability of different design ideas. Our rapid prototyping facility allow United Pacific to compress design cycles, improve manufacturing planning, shorten concept-to-shelf time, most importantly, generate new and innovative products.

DESIGN

Located near some of the nation's most progressive automotive design centers, United Pacific established the UP Design Studio in 2002 to consolidate our position as the design leader in the automotive industry. UP Design Studio utilizes the latest generation of computer aided design (CAD) and studio/graphic software. The design studio is equipped with the newest computers and rapid prototyping systems. In addition, UP Design Studio is staffed by graduates from the nation's most prestigious design colleges. Unlike our competitors, United Pacific's design and manufacturing capabilities mean that we carry more new and original items than our competitors. The establishment of the design studio will enable us to generate even more new products with significant shorter concept-to-shelf time. The reduction in development cost mean that we can develop products utilizing design based development processes. Design based product development allows United Pacific to create new product concepts based on designs incorporating driver demands and needs instead of economic considerations. United Pacific's emphasis on design distinguishes and positions us ahead of our competitors.



WARRANTY

With LED (Light Emitting Diodes) rated at 100,000 hours of operation and solid-state construction, United Pacific's LED lights are extremely reliable and durable. Purchase with confidence, United Pacific offers a complete line of LED lighting products with extended or limited lifetime warranties. Please see the warranty policy page for more details.

INVENTORY AND SHIPPING

United Pacific carries over 20,000 items in our California distribution center. No other company in the heavy duty trucking industry can match United Pacific in the variety and range of in-stock inventories. With an order fill rate of over 98.5%, United Pacific is the largest and most reliable supplier in the industry. Our shipping department ships 96.8% of all orders within 24 hours and 98.9% within 48 hours. United Pacific's vast inventory and prompt shipping has made United Pacific the only source for our customer's chrome and lighting needs.



HARD AT WORK FOR THE ENVIRONMENT



United Pacific
132,000 sq ft

Distribution Center
Long Beach, CA

100%

reduction in potable water used for landscaping

40%

reduction in total energy use due to high-efficiency mechanical and lighting systems

82%

of construction waste was diverted from landfills

LEED ACCOMPLISHMENTS

Sustainable Sites

- On-site bicycle storage, showers and changing areas for company employees.
- Preferred parking for low-emitting, fuel-efficient and carpool vehicles.
- Storm water is infiltrated on-site and treated to remove contaminants to reduce environmental impact on local waterways.

Water Efficiency

- In addition to using reclaimed water, drought-tolerant plants and a high-efficiency irrigation system were installed to reduce the use of potable water for irrigation by 100%.

Energy and Atmosphere

- Efficient HVAC equipment and a lighting system with daylight controls reduces energy consumption by over 30%.
- Enhanced commission verifies that the building's energy and water-related systems are performing as intended by the initial design.

Indoor Environmental Quality

- Building ventilation systems was designed to provide enhanced levels of fresh outside air to building occupants.
- Interior finishes (plants, sealants, adhesives, coatings, carpet systems and composite wood) were selected with low levels of volatile organic compounds (VOCs) to reduce indoor air contamination.



NEW ITEMS

January 2020

100%LED

DOT

10 High Power LED Projection Headlight with LED Turn Signal & LED Position Light Bar

- Unique multiple projector headlight design delivering bright illumination
- All LED dual function headlight with low beam and high beam
- Fits Peterbilt 357/365/378/379 with OE dual 4" x 6" Headlight Housing, and fits fender mounted headlights on Kenworth T600/T800/W900, Freightliner Classic, Western Star 4800/4900/6900 series
- All-new durable fender Liner included to protect of the rear of headlight from water, road salt, and debris
- Universal design fits many vehicles with dual 4" x 6" fender mounted headlights

LED Turn Signal White LED Position Light LED Turn Signal



High Power LED High Beam

High Power LED Low Beam

10 HIGH POWER LED



Technical Specification	
Low Beam Application	High Beam Application
5700 Lumens	5700 Lumens
6300K	6300K
2.1 amps	2.25 amps

35823	Chrome	Driver - 1 Pc. / Color Box
35824	Chrome	Passenger - 1 Pc. / Color Box
35825	Blackout	Driver - 1 Pc. / Color Box
35826	Blackout	Passenger - 1 Pc. / Color Box



100%LED

DOT

White LED Position Light LED Turn Signal



High Power LED High Beam High Power LED Low Beam

LED Projection Headlight w/ LED Position Light For 2018+ Freightliner Cascadia

- Projection headlight with white LED position light
- Headlight assembly for 2018+ Freightliner Cascadia trucks
- Patent pending headlight lens design for improved look and visibility
- Easy installation, simply plugs into existing headlight wiring harness. Position light & turn signal requires additional wiring
- DOT/SAE Approved

Technical Specification	
Low Beam Application	High Beam Application
1600 Lumens	1200 Lumens
7000K	6000K
2.7 amps	2.39 amps

35819	Chrome	Driver - 1 Pc. / Box
35820	Chrome	Passenger - 1 Pc. / Box
35821	Blackout	Driver - 1 Pc. / Box
35822	Blackout	Passenger - 1 Pc. / Box

Chrome Air Intake Grille with LED Light for 2013+ Peterbilt 579

- Air intake grille for 2013 and newer Peterbilt 579 trucks
- Replaces OEM# L46-6062 / L46-6062R
- Dual function 12" LED light bar

14 LED Light Bar

41775	Amber LED/Amber Lens	Driver - 1 Pc. / Card
41781	Amber LED/Amber Lens	Passenger - 1 Pc. / Card
41776	Amber LED/Clear Lens	Driver - 1 Pc. / Card
41782	Amber LED/Clear Lens	Passenger - 1 Pc. / Card

19 LED Reflector Light Bar

41777	Amber LED/Amber Lens	Driver - 1 Pc. / Card
41783	Amber LED/Amber Lens	Passenger - 1 Pc. / Card
41778	Amber LED/Clear Lens	Driver - 1 Pc. / Card
41784	Amber LED/Clear Lens	Passenger - 1 Pc. / Card

24 GLO LED Light Bar

41779	Amber LED/Amber Lens	Driver - 1 Pc. / Card
41785	Amber LED/Amber Lens	Passenger - 1 Pc. / Card
41780	Amber LED/Clear Lens	Driver - 1 Pc. / Card
41786	Amber LED/Clear Lens	Passenger - 1 Pc. / Card

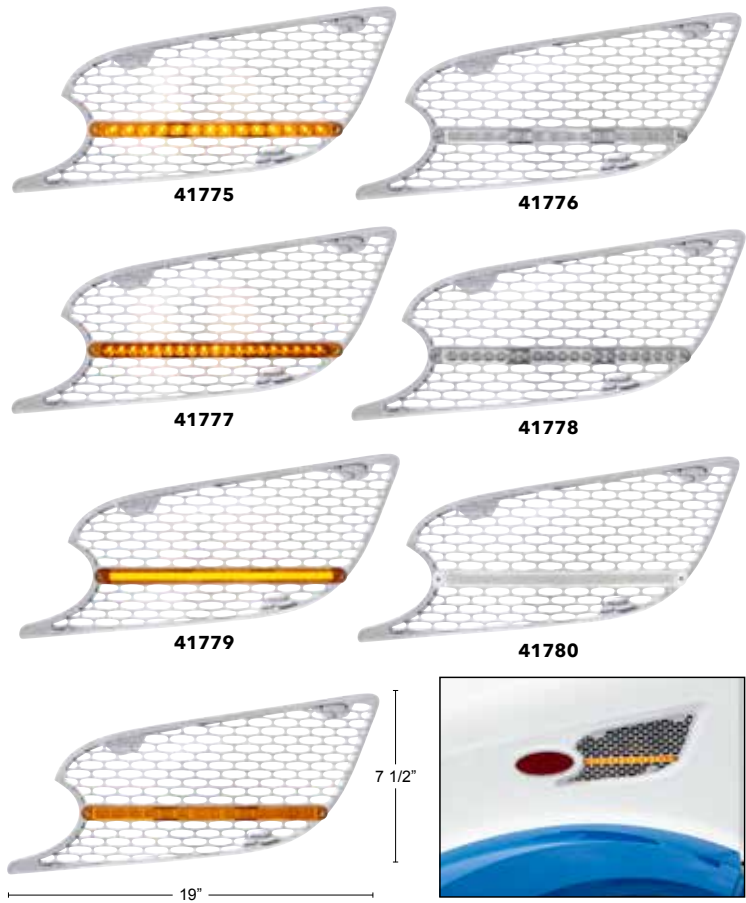

60 PCS. CONVENIENCE PACK



33mm x 3-7/8" Chrome Plastic Bullet Nut Cover - Thread-On (60/Pack)

- Fits over standard 33mm lug nuts on hub piloted wheel
- Designed to cover up and hide the lug nut flange washer
- Convenience pack, includes 60 nut covers to dress up your entire truck

10564CB 60 Pcs. / Color Box

60 PCS. CONVENIENCE PACK



33mm x 4-1/4" Chrome Plastic Stiletto Nut Cover - Thread-On (60/Pack)

- Fits over standard 33mm lug nuts on hub piloted wheel
- Designed to cover up and hide the lug nut flange washer
- Convenience pack, includes 60 nut covers to dress up your entire truck

10778CB 60 Pcs. / Color Box

60 PCS. CONVENIENCE PACK



33mm x 4-3/8" Chrome Plastic V-Spike Nut Cover - Push-On (60/Pack)

- Fits over standard 33mm lug nuts on hub piloted wheel
- Designed to cover up and hide the lug nut flange washer
- Convenience pack, includes 60 nut covers to dress up your entire truck

10554CB 60 Pcs. / Color Box



Matte Black Rear Axle Cover w/ 33mm Spike Thread-on Nut Cover

- Fits most 20", 22-1/2" and 24-1/2" wheels with 11-1/4" bolt circle/center applications
- Removable hub cap for easy inspection of axle
- Each set includes 1 cover, 1 cap, and 10 nut covers
- Replacement parts: black 33mm spike thread-on nut cover (item # 10548B)

10337 Pointed - 1 Pc. / Color Box **(NEW)**

10342 Dome - 1 Pc. / Color Box



4.5" 24 High Power LED Work Light With "X" Light guide

- High power SPOT & FLOOD beam combination work light with unique 15 LED "X"light guide design
- Water resistant die cast housing, polycarbonate lens provides maximum protection & durability
- Solid state design resists shock and vibration
- 5200 lumens, IP 67 water resistant
- 12VDC - 24VDC

36454 Amber - 1 Pc. / Color Box

36455 Blue - 1 Pc. / Color Box

36456 Red - 1 Pc. / Color Box

36457 White - 1 Pc. / Color Box

⊗ Light Guide High Power LED Front Spot Light



High Power LED Front Flood Light



NEW ITEMS

February 2020



6 LED Amber Turn Signal Light for 2018+ Freightliner New Cascadia

- Corrosion resistant polycarbonate lens and housing with 6 LED's and OEM style connector
- Direct OEM replacement for pn A06-90212-002

36002 Driver - 1 Pc. / Color Box

36003 Passenger - 1 Pc. / Color Box



5 LED Reflector Clearance/Marker Light with Side Ditch Light

- Clearance/marker light with 3 amber LED's, and 2 LED white side lights
- Down firing side LED ditch lights create better visibility and safety at night
- High quality chrome bezel for durability and shine
- 12 volt 2-wire hookup; 40 lumens
- SAE/DOT P2 and IP67 water resistant

DOT

IP67
WATER RESISTANT

39311B Amber LED / Clear Lens - 1 Pc. / Bulk

39312B Red LED / Clear Lens - 1 Pc. / Bulk

39313B White LED / Clear Lens - 1 Pc. / Bulk



2 LED Fog Light for 2018+ Volvo VNL

- Fits 2018+ Volvo VNL 300, 400, 740, 760, 860 models
- Easy installation, fits OEM housing
- Replacement for OEM # 82775826 (driver) / 82775828 (passenger)
- SAE/DOT FMVSS108

DOT

35829 Driver - 1 Pc. / Box

35830 Passenger - 1 Pc. / Box



Chrome Billet Aluminum Diamond Pedal Set for 2014+ Peterbilt 567, 579 & 587

- Heavy duty aluminum construction ensures strength and durability
- CNC machined diamond design for the ultimate non-slip grip
- Easy installation w/ included 3M adhesive tape & alcohol pad
- Set includes: Gas pedal x 1, Break pedal x 1, Clutch pedal x 1

70369 1 Set / Color Box



Sitting Pig Ornament

- Detailed die-casting with beautiful chrome plating
- Easy installation on any vehicle with three mounting studs
- Approximately 5-1/2" x 3-1/2" x 4-1/2"
- Mounting pad and hardware included
- Perfect decorator item for home, office and man cave

72046 Chrome - 1 Pc. / Color Box

72047 Black - 1 Pc. / Color Box

60 PCS. CONVENIENCE PACK



33mm x 4-3/8" Chrome Plastic V-Spike Nut Cover - Thread-On (60/Pack)

- Fits over standard 33mm lug nuts on hub piloted wheel
- Designed to cover up and hide the lug nut flange washer
- Convenience pack, includes 60 nut covers to dress up your entire truck

10553CB 60 Pcs. / Color Box

60 60 PCS. CONVENIENCE PACK



33mm x 3-3/4" Chrome Plastic Crown Nut Cover - Thread-On (60/Pack)

- Fits over standard 33mm lug nuts on hub piloted wheel
- Designed to cover up and hide the lug nut flange washer
- Convenience pack, includes 60 nut covers to dress up your entire truck

10562CB 60 Pcs. / Color Box

60 60 PCS. CONVENIENCE PACK



33mm x 4-3/4" Chrome Plastic Razor Nut Cover w/ Flange- Thread-On (60/Pack)

- Fits over standard 33mm lug nuts on hub piloted wheel
- Designed to cover up and hide the lug nut flange washer
- Convenience pack, includes 60 nut covers to dress up your entire truck

10583CB 60 Pcs. / Color Box

60 60 PCS. CONVENIENCE PACK



33mm x 4-3/8" Chrome Plastic Razor Nut Cover - Thread-On (60/Pack)

- Fits over standard 33mm lug nuts on hub piloted wheel
- Designed to cover up and hide the lug nut flange washer
- Convenience pack, includes 60 nut covers to dress up your entire truck

10781CB 60 Pcs. / Color Box



Matte Black Dome Axle Cover w/ 33mm Spike Thread-on Nut Cover

- Fits most 20", 22-1/2" and 24-1/2" wheels with 11-1/4" bolt circle/center applications
- Removable hub cap for easy inspection of axle
- Made from plastic that is high-impact, light-weight, and corrosion resistant
- Each set includes 1 cover, 1 cap, and 10 nut covers
- Replacement parts: black 33mm spike thread-on nut cover (item # 10548B)

10341 Dome - 1 Pc. / Color Box **(NEW)**

10342 Pointed - 1 Pc. / Color Box



Chrome Glove Box Cover for 2008-2017 Freightliner Cascadia

- Beautiful chrome plated molded plastic glove box door cover
- Includes 1 piece glove box door cover and 1 piece latch trim
- Easy installation with double sided tape
- Show winning shine, dress up your truck

42439 1 Pc. / Card



Bumper Mesh for 2018+ Freightliner Cascadia - Driver & Passenger

- Mesh grille insert
- Replace OEM number: 21-28985-000 (item # 42478)/
21-28985-001 (item # 42479)

42486 1 Pair / Box

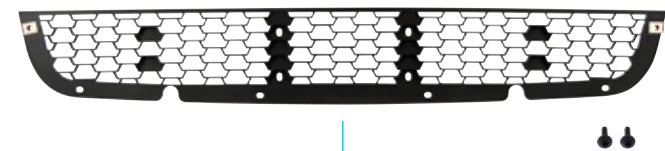

Bumper Mesh for 2018+ Freightliner Cascadia - One Piece

- Mesh grille insert
- Replace OEM number: 21-28985-000

42487 1 Pc. / Box



110861



110862



Stainless Steel Flag Holder

- Stainless flag holder only
- Fits United Pacific U.S.A. flag item No. C9003

110861 3 Post - 1 Pc. / Bulk

110862 5 Post - 1 Pc. / Bulk

NEW PACKAGING



Chrome Piston 13/15/18 Gearshift Knob w/ Adapter

- Chrome piston 13/15/18 speed gearshift knobs
- Mounting adapter (UP Item # 70603B) and gearshift knob
(UP item # 70160) available separately

70613 1 Pc. / Card

NEW PACKAGING



Chrome Ball 13/15/18 Speed Gearshift Knob with Adapter

- Chrome ball 13/15/18 speed gearshift knobs
- Mounting adapter (UP Item # 70603B) and gearshift knob
(UP Item # 70606B) available separately

70612 1 Pc. / Card



24" x 30" United Pacific Logo Mud Flap

- 24"x30" United Pacific Black Rubber Mud Flap

10588 1 Pc. / Bulk

NEW ITEMS

March 2020



GRILL GUARD & MOUNTING BRACKET SET

Heavy-Duty Stainless Steel
+
Polished Stainless Finish

Easy Installation / No Drilling
Fold Down Latch System
for Easy Access

304 Stainless Steel Grille Guard

- Heavy duty 3" tubular welded construction provides strong protection to bumper and grille
- 14 gauge polished stainless steel
- Approximate size: 90-1/2" x 25-1/2" x 11-3/4", Weight: 52.25 lb
- Pallet freight shipment only
- **Mounting bracket sold separately**

80000 1 Pc. / Box

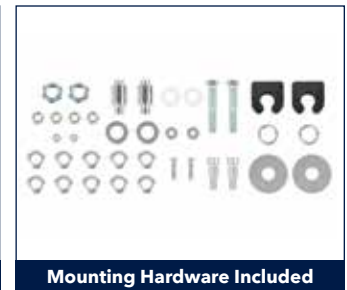

Grille Guard Mounting Bracket Set

- Durable steel construction with zinc plated hardware. Easy installation on OEM tow hook receivers
- Bracket set designed for grille guard to tilt forward for easy access to bumper, grille and lights, and clears hood when opening

80001 For Cascadia (2008-2017) - 1 Set / Box

80002 For KW T660 (2008-2017) & T680 (2013-2020) - 1 Set / Box

80003 For PB 579 (2012-2020) & PB 587 (2010-2016) - 1 Set / Box

80004 For Volvo VNL (2004-2017) - 1 Set / Box

80005 For IH Prostar (2006-2017) & IH LT (2018-2020) - 1 Set / Box

FLAT-RATE* PRICES *On Stainless Steel Grill Guard*

Zone A

\$175 (1) / \$300 (up to 4 on same pallet)

Zone B

\$200 (1) / \$335 (up to 4 on same pallet)

Zone C

\$225 (1) / \$365 (up to 4 on same pallet)

Zone D

\$300 (1) / \$465 (up to 4 on same pallet)

Zone E

\$315 (1) / \$490 (up to 4 on same pallet)

Zone F

\$335 (1) / \$535 (up to 4 on same pallet)

Mexico & Latin America Special Quote

*Flat-Rate pricing does not include cost of parts. All prices are subject to change. HI, AK and international orders are extra. Pallet cost is included in the flat rate shipping cost.

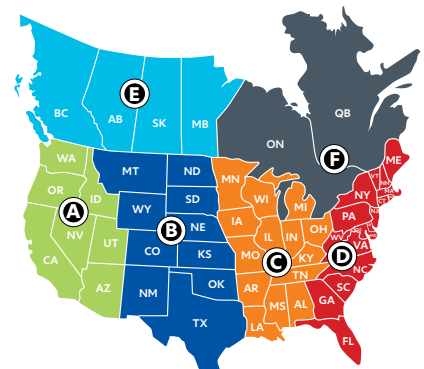

DOT

H7 Halogen Bulb High Beam H7 Halogen Bulb Low Beam



Technical Specification

Low Beam Application	High Beam Application
H7 / 55 Watt	H7 / 55 Watt
4.58 Amps	4.58 Amps
12V DC Input	12V DC Input

Projection Headlight With LED Sequential Turn and DRL For 2011+ Peterbilt 579/587

- Headlight assembly for Peterbilt 579/587 trucks
- Projection headlight with LED position light and LED Sequential turn signal
- Patent Pending headlight lens design with reflective turn signal diffusers for wider visibility
- Easy connection, plugs into existing wiring harness
- DOT/SAE Approved

35779	Chrome	Driver - 1 Pc. / Color Box
35780	Chrome	Passenger - 1 Pc. / Color Box
35781	Blackout	Driver - 1 Pc. / Color Box
35782	Blackout	Passenger - 1 Pc. / Color Box

20 PCS. CONVENIENCE PACK



33mm x 4-1/8" Black Spike Nut Cover - Thread-On (60/Pack)

- Fits over standard 33mm lug nuts on hub piloted wheel
- Designed to cover up and hide the lug nut flange washer
- Convenience pack, includes 60 nut covers to dress up your entire truck

1000CB 60 Pcs. / Color Box



Black Grille W/ Bug Screen For 2017+ International LT

- Fits 2017+ International LT
- Unique curved grille design
- Bug screen included
- Mounting hardware included
- OEM number: 4039860C92

21335 1 Pc. / Box



Chrome Door Switch Cover With Power Windows/ Mirrors/Door Locks For 2018+ Freightliner Cascadia

- For drivers door equipped with power windows, power mirrors, power door locks
- Quality molded plastic with beautiful long lasting chrome plating
- Easy installation with double sided tape
- Sold individually. Related item: 42446, 42447, 42448

42445 1 Pc. / Card



Chrome Door Switch Cover With Power Windows/ Mirrors For 2018+ Freightliner Cascadia

- For drivers door equipped with power windows, power mirrors
- Quality molded plastic with beautiful long lasting chrome plating
- Easy installation with double sided tape
- Sold individually. Related item: 42445, 42447, 42448

42446 1 Pc. / Card



Chrome Door Switch Cover With Power Windows/Door Locks For 2018+ Freightliner Cascadia

- For passenger door equipped with power windows, door locks
- Quality molded plastic with beautiful long lasting chrome plating
- Easy installation with double sided tape
- Sold individually. Related item: 42445, 42446, 42448

42447 1 Pc. / Card



**COMPETITION
SERIES**

2 White LED Chrome License Plate Light/Utility Light - Competition Series

- Super bright white LED utility/license light, 12 volt
- Chrome housing, water resistant
- Includes mounting pad & screws

39909 1 Pc. / Card



110863



110864

Stainless Steel Flag Holder with Flags

- Stainless flag holder with flags
- Show your patriotism

110863 3 Flags - 1 Set / Card

110864 5 Flags - 1 Set / Card



99193



99194



99195

United Pacific Work Light Display

- Polished stainless steel display base
- Completely assembled and wired
- 12 Volt power supply included

99193 36671/36672/36507/36965 - 1 Pc. / Box

99194 36461/36462/36506/36965 - 1 Pc. / Box

99195 36463/36464/36506/36965 - 1 Pc. / Box

NEW ITEMS

April 2020



100%LED

DOT

10 High Power LED “Chrome” Projection Headlight Assembly with LED Turn Signal & LED Position Light Bar With Housing and Bracket Assembly

- All LED dual function headlight assembly with chrome housing and die cast mounting arm
- Fits Peterbilt 357/359/365/367/378/379/389/567 and other custom applications
- Easy installation with OE mounting hole positions. Includes long wiring loom for electrical hookup
- Low Beam: 1,600 Lumens, 2.1 Amps. High Beam: 2,400 Lumens, 2.25 Amps
- 12V-24V DC, total power consumption 70 Watts / 6.35 amps @ 12VDC

35775 Driver - 1 Pc. / Color Box

35776 Passenger - 1 Pc. / Color Box

Technical Specification	
Low Beam Application	High Beam Application
1600 Lumens	2400 Lumens
5700K	5700K
2.1 amps	2.25 amps



36747



OE Style Plug



36748



3 LED Fender Turn Signal/Parking Light For Kenworth T680/T700/T880

- Amber or clear lens with 3 amber LED
- Mounting studs and foam gasket included. Wiring is with OE style connector
- Aftermarket replacement for OEM P54-1211 and P54-1211R

36747 Amber LED / Amber Lens - 1 Pc. / Card

36748 Amber LED / Clear Lens - 1 Pc. / Card



33mm x 4 7/8” Chrome Plastic Super Spike Nut Cover - Push-On (10 Pack)

- Fits over standard 33mm lug nuts on hub piloted wheel
- Designed to cover up and hide the lug nut flange washer
- Convenience pack, includes 10 nut covers to dress up one wheel

10570 10 Pcs. / Color Box



33mm X 4-3/4” Chrome Super Spike Nut Cover - Thread-On (10 Pack)

- Fits over standard 33mm thread-on nuts on hub piloted wheel
- Designed to cover up and hide the lug nut flange washer
- Convenience pack, includes 10 nut covers to dress up one wheel

10569 10 Pcs. / Color Box



24 High Power LED 7" Light With Dual Color Position Light

- 24 LED high power 7" light with 8 dual color LED position light
- LED white/amber position light bar changes from white to amber when sequential light is activated
- Sequential amber position light can be connected for lefthand or righthand operation
- High beam: 5000 Lumens; Low beam: 2000 lumens; Position light-white: 200 lumens; Position light-amber: 125 lumens
- Easy connection, plugs into existing wiring harness, position light requires additional wiring. Installation in some OE light housings may require modification
- For off-road use only

Technical Specification	
Low Beam Application	High Beam Application
2000 Lumens	5000 Lumens
6000-6500K	6000-6500K
12VDC - 24VDC input	12VDC - 24VDC input



36452 1 Pc. / Color Box

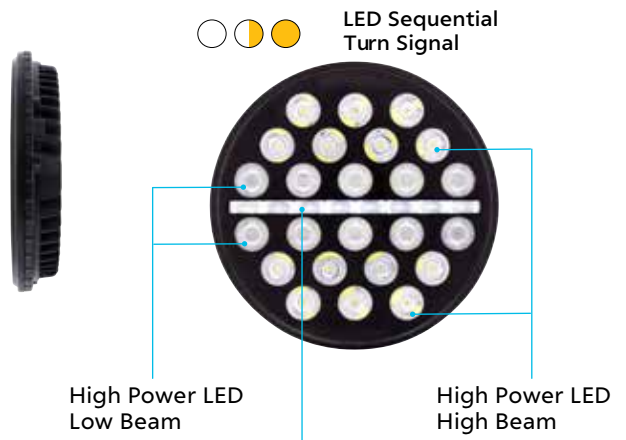

23496



23498



23497



23499



Chrome Thread-on Shift Knob

- High quality die-cast aluminum with triple chrome plating
- Inside thread 1/2"-13
- Dress up your truck with show winning shine
- Designed to work best with UP shift knob adaptor, # 70589B. May also work with other adaptors with 1/2"-13 thread

23496 Plain - 1 Pc. / Card

23497 Skull - 1 Pc. / Card

23498 Ace of Spades - 1 Pc. / Card

23499 Eagle - 1 Pc. / Card



2019 Truck New Item Flyer Collection

UF1219 1 Pc. / Bulk



Truck Steering Wheel Catalog

UCSW01 1 Pc. / Bulk

NEW ITEMS

May 2020



70788

70789

70790

70791

*Lower cover, range button and shifter extension sold separately

Chrome 13/15/18 Speed Thread-on Gearshift Knob w/ Adaptor

- Fits 13/15/18 gearshift knobs
- Quality die cast metal with beautifully chrome plated finish
- Inside thread 1/2"-13
- Mounting adaptor: Item No. 70589B available separately

70788	Chrome Shift Knob - 1 Pc. / Card
70789	Chrome Skull Shift Knob - 1 Pc. / Card
70790	Chrome Ace of Spade Shift Knob - 1 Pc. / Card
70791	Chrome Eagle Shift Knob - 1 Pc. / Card

10 PCS. CONVENIENCE PACK

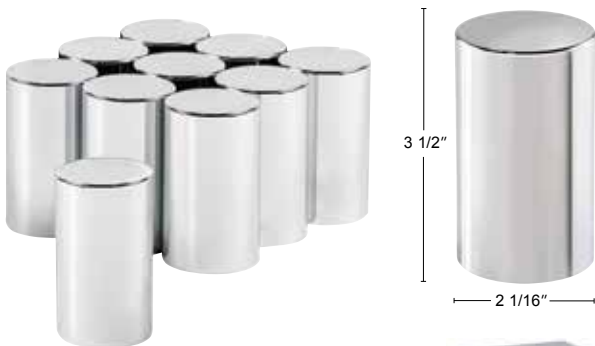

33mm x 4 7/8" Chrome Plastic Super Spike Nut Cover - Push-On (10 Pack)

- Fits over standard 33mm lug nuts on hub piloted wheel
- Designed to cover up and hide the lug nut flange washer
- Convenience pack, includes 10 nut covers to dress up one wheel

10013 10 Pcs. / Color Box



8 LED Oval Wide Angle Driving/Work Light

- 8 LED oval work light, wide angle design
- 12v-36v application, 1920 lumens

36515 1 Pc. / Card

36515B 1 Pc. / Bulk



INCLUDES

Wheel



88309 88317

Hub



Horn Button



88120

United Pacific Steering Wheel Display - Type VII

- Includes United Pacific steering wheel: Item No. 88309/88317
- Includes United Pacific matching flame bezel and chrome hub/horn button

99199 1 Set / Box



INCLUDES

Wheel



88277 88280

Hub



88284 88287

Horn Button



88120

United Pacific Steering Wheel Display - Type VIII

- Includes United Pacific steering wheel: Item No. 88277/88280
- Includes United Pacific chrome hub/horn button: Item No. 88277/88284/88280/88287/88120

99200 1 Set / Box



United Pacific Steering Wheel Display - Type IX

- Includes United Pacific steering wheel: Item No. 88283/88279
- Includes United Pacific chrome hub/horn button: Item No. 88283/88290/88279/88286/88120

99201 1 Set / Box



LED Header Sign

- United Pacific header/fixture signs
- LED header
- Perfect for product identification

99036 1 Pc. / Bulk



United Pacific Light Display - 7", 5-3/4", 4"x6", 5"x7"

- Quality point-of-purchase display made of steel and gloss black powder coated
- Includes United Pacific items: 31084, 31267, 34125, 31087
- Includes 12V power supply unit & wall plug
- Completely assembled and wired
- Display approximate size: 33-3/4" L X 12-3/4" W X 4 -1/2" H

99196 1 Pc. / Box

NEW ITEMS

June 2020

NEW & IMPROVED



Chrome Aluminum Gun Cylinder Steering Wheel Spinner

- Designed to reduce steering effort and fatigue
- Time tested quality and durability for commercial trucks & heavy equipment
- Heavy duty ball bearing design with chrome metal base and mounting brackets
- Includes 3 types of mounting brackets to fit the steering wheel spoke, or the steering wheel rim on some vehicles
- New & Improved! Now fits on newer vehicles with thick steering wheels
- Note/Warning: Universal design may require bracket modification to fit application. May cause permanent damage to the steering wheel, especially wood, rubber & leather
- Check laws and/or regulations in your state, county, and/or municipality regarding installation and use of this product



70106

1 Pc. / Color Box

10 10 PCS. CONVENIENCE PACK

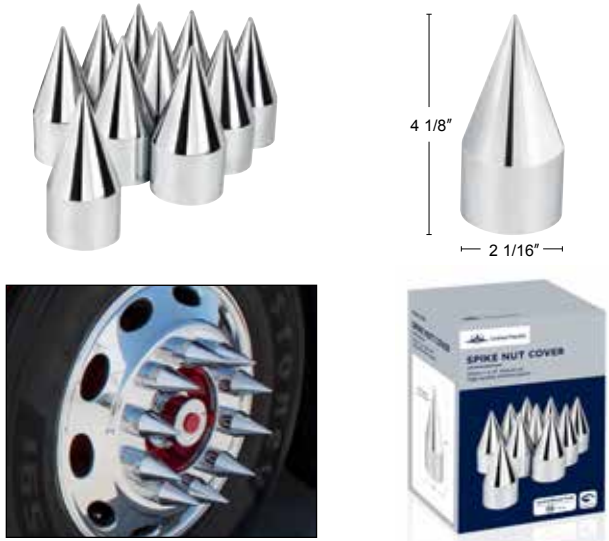

33mm X 4 1/8" Chrome Plastic Spike Nut Cover - Thread-On (10 Pack)

- Beautiful high quality chrome plated finish with triple chrome plating process
- Fits over standard 33mm lug nuts on hub piloted wheel
- Designed to cover up and hide the lug nut washer
- Available in various height
- Convenience pack, includes 10 nut covers to dress up one wheel

10007 10 Pcs. / Color Box

20 20 PCS. CONVENIENCE PACK



33mm X 2 5/8" Chrome Plastic Bullet Nut Cover W/ Flange - Push-On (20 Pack)

- Chrome plastic bullet push-on nut cover for hex nuts and bolts
- Beautiful high quality chrome plated finish with triple chrome plating process
- Fits over standard 33mm lug nuts on hub piloted wheels
- Designed to cover up and hide the lug nut flange washer
- Convenience pack, includes 20 nut covers to dress up two wheels

10060 20 Pcs. / Color Box

New Upgraded Slim Low Profile Design

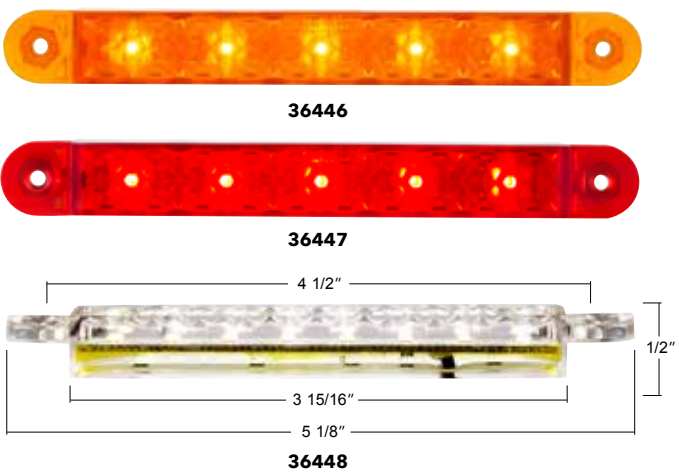

5" SMD LED Light Strip With Hard Wire

- 5 Super bright SMD LED strip with fully sealed electronics
- 12VDC, available in dual function red or amber, or single function white
- Captive #6-32 nuts for rear flush mounted installation
- For clean and proper mounting, a 3-15/16 X 5/8" rectangular pocket is required
- Please see "Attachment-Line Art" for more dimensional details

36446 Amber LED - 1 Pcs. / Card
36447 Red LED - 1 Pcs. / Card
36448 White LED - 1 Pcs. / Card



United Pacific Double Face Light Display

- Polished stainless steel display base
- Includes item # 38103, 37083, 37125, 39377
- Completely assembled and wired
- 12 Volt power supply included

99198 1 Pcs. / Box



Introducing the new **UPtruckparts.com** with a dealer portal

Contact CSR for details

NEW ITEMS

July 2020

Aero Full-Moon Rear Axle Cover Kit - Chrome

- Full disc wheel cover reduces aerodynamic drag gives a streamlined look
- Easy to remove and replace for wheel inspection and access tire valve stem pressure checks
- Designed specifically for Alcoa 22.5" X 8.25" aluminum wheels
- Heavy duty inner mounting base with easy snap-on aero cover
- Includes thread-on nut covers, wheel protector film, and top cover removal tool
- Warning: Requires a minimum of 3 threads extending through the top of each lug nut for proper installation
- Recommended nut cover installation tool pn. 10259 sold separately
- No warranty for damage caused by road debris, rocks, chemicals, truck washes, etc

10326 1 Set / Color Box



Stellar Pluto+ Duo Bundle Headset

- A Trucker's "best friend" headset offering battery life for longest talk time, best comfort, unique style and quality sound
- "Pluto" mode is single earpiece and 30 hours of talk time / 500 hours of stand-by time
- "Duo" mode adds a stereo earpiece for 60 hours of talk time / 900 hours stand-by time
- "Duo" earpiece is also a USB power bank to charge other devices on the go
- Noise Armor® technology offers the best noise cancellation for truckers. No more "I can't hear"
- Bluetooth 5.0 compatible, and has longer range and more connectivity for your devices
- Durable carrying case, dual USB car charger, and USB cable included

95002 1 Set / Box



COMPETITION SERIES



LED Headlight With LED Turn Signal & LED Position Light Bar For 2008+ Kenworth T660

- High Power 100% LED headlight assembly
- 12 Amber LED turn signal and 5 Amber LED marker light
- 60 White LED position light bar
- Headlight lens design for improved look and visibility. Patent number US880,764
- Easy connection, plugs into existing wiring harness

Technical Specification	
Low Beam Application	High Beam Application
1600 Lumens	2400 Lumens
6000K	6000K
2.7 amps	2.7 amps

35771	Chrome	Driver - 1 Pc. / Color Box
35772	Chrome	Passenger - 1 Pc. / Color Box
35773	Blackout	Driver - 1 Pc. / Color Box
35774	Blackout	Passenger - 1 Pc. / Color Box



100%LED

DOT

White LED Position Light High Power LED High Beam High Power LED Low Beam LED Side Marker



White LED Position Light LED Turn signal



Unique Patent Lens Design Adds Definition to LED Side Market



COMPETITION SERIES

Headlight For 2008+ Peterbilt 382/384/386/387

- Fits Peterbilt 387 1999 and later, and Peterbilt 386 2005 and later
- OEM Part # 16-09190-L/16-09190-R
- High/Low beam: Halogen 9007 (HB5) 12V, 55/65 Watt, bulb included
- Turn signal: 4157, bulbs included
- SAE/DOT FMVSS 108

Technical Specification	
Low Beam Application	High Beam Application
12V DC Input	12V DC Input
9007 (HB5) Light Bulb	9007 (HB5) Light Bulb
65 Watt	55 Watt

35769	Driver - 1 Pc. / Color Box
35770	Passenger - 1 Pc. / Color Box



DOT

4157 Bulb Turn Signal

4157 Bulb Turn Signal



Halogen 9007 (HB5) Bulb (High/Low Beam)



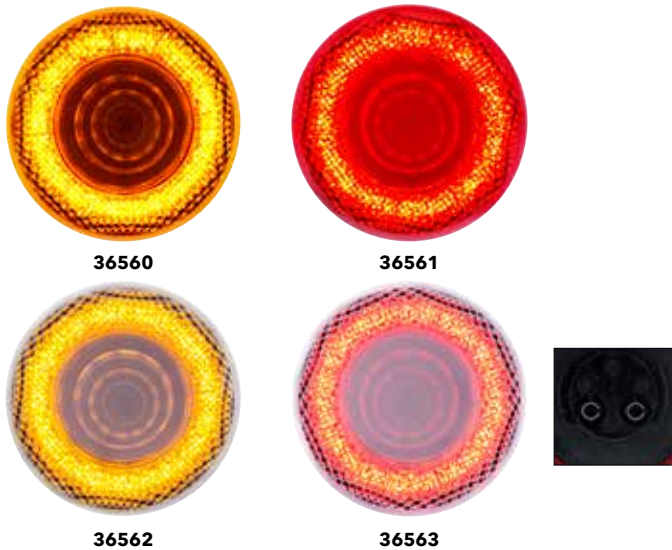

12 LED 2.5" Mirage Clearance/Marker Light

- Mirage lens design gives unique infinity or double vision effect
- Durable plastic housing with 2 contact female plug. Recommended male plug, item # 34210
- DOT/SAE and FMVSS108. Lifetime warranty



36560	Amber LED / Amber Lens - 1 Pc. / Card
36561	Red LED / Red Lens - 1 Pc. / Card
36562	Amber LED / Clear Lens - 1 Pc. / Card
36563	Red LED / Clear Lens - 1 Pc. / Card



Saber Rectangular LED Marker Light

- Unique LED light track technology, DOT/SAE P2 certified
- Includes Chrome Bezel
- Durable Sealed SMD LED's withstand vibration and IP67 rated
- 12 volt 2-wire hookup using .180" bullet plugs
- Surface mounting holes are approximately 4-13/16" apart

36819	Amber Lens - 1 Pc. / Card
36820	Red Lens - 1 Pc. / Card



40 PCS. CONVENIENCE PACK



9 LED 2" Clearance/Marker Light

- Super bright energy efficient LED with epoxy sealed electronics
- Easy electrical connection with standard 2-pin clearance light female terminals
- Recommend standard commercial 2-pin male plug, sold separately, item no. 34210
- Also recommend flush mount rubber grommet for installation, sold separately, item no. 31505

38170CB	Amber LED / Amber Lens - 40 Pcs. / Color Box
38171CB	Red LED / Red Lens - 40 Pcs. / Color Box
38362CB	Amber LED / Clear Lens - 40 Pcs. / Color Box
38363CB	Red LED / Clear Lens - 40 Pcs. / Color Box

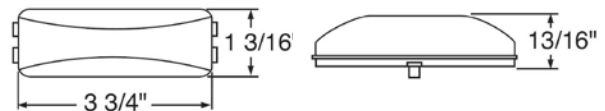

Incandescent Rectangular Fender Mount Clearance/Marker Light - Amber & Red Lens

- Functions as both front and rear clearance light for trailers over 80 inches wide
- High quality injection molded dual color, amber and red plastic lens
- Polycarbonate lens sonically sealed to housing to prevent moisture intrusion
- Grease filled terminals to prevent corrosion
- Recommend mounting/quick-connect base: item # 30919 (chrome) or item # 33006 (black)

31050	1 Pc. / Bulk
--------------	---------------------



1998-2015 C500	1998-2015 C800
1998-2008 T300	1993-1997 T450
1985-2015 T600	1987-2015 T800
1998-2019 W900	1982-1999 T400

Windshield Sunshade for 1982-2018 Kenworth Trucks

- Blocks damaging UV rays & keeps interior cool
- Polyethylene bubble with reflective thermal coating
- Accordion fold and closure strap for quick & easy storage
- Includes suction cups for secure installation to windshield

98990 1 Pc. / Card



Windshield Sunshade for 2002-2020 Volvo VNL

- Blocks damaging UV rays & keeps interior cool
- Polyethylene bubble with reflective thermal coating
- Accordion fold and closure strap for quick & easy storage
- Includes suction cups for secure installation to windshield

98991 1 Pc. / Card



Windshield Sunshade for 1999-2017 Peterbilt 384/386/388

- Blocks damaging UV rays & keeps interior cool
- Polyethylene bubble with reflective thermal coating
- Accordion fold and closure strap for quick & easy storage
- Includes suction cups for secure installation to windshield

98992 1 Set / Card



United Pacific LED Deluxe Light Display

- United Pacific LED deluxe light display

99018 1 Pc. / Box



Tire Checker Bat

- United Pacific 17" aluminum tire checker

99060 1 Pc. / Bulk

NEW ITEMS

August 2020



34131



34132



34133



34134

4" X 6" Heated LED Headlight

- Features a heating system that automatically de-ices the headlight according to ambient temperature
- Durable glass lens with heavy duty aluminum housing
- Plug & play with standard H4 style connector plug for ease of installation
- Available in high beam and low beam with choice of chrome or black inner liner
- Low beam: 1000 lumens, high beam: 1200 lumens, 12-24VDC, 20 watts

34131	Chrome	Low Beam - 1 Pc. / Color Box
34132	Chrome	High Beam - 1 Pc. / Color Box
34133	Black	Low Beam - 1 Pc. / Color Box
34134	Black	High Beam - 1 Pc. / Color Box

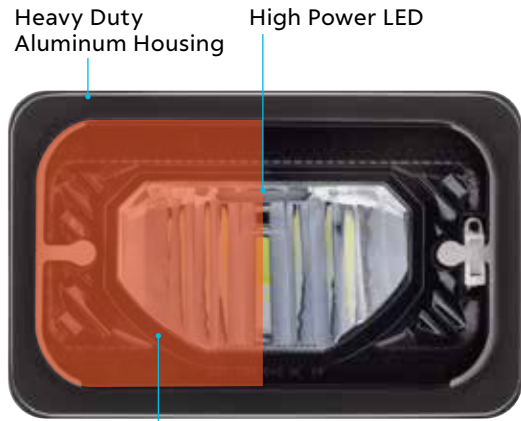

Electrical Heating System
Automatic De-ices the Headlight
According to Ambient Temperature



100% LED

DOT

Technical Specification

Low Beam Application
1000 Lumens
12VDC - 24VDC Input
20 Watts

High Beam Application
1200 Lumens
12VDC - 24VDC Input
24 Watts



36815



36817



36816



36818

IP67
WATER RESISTANT

4 LED Light Track Clearance/Marker Light

- Unique LED Light Track technology
- High quality chrome bezel for durability and shine
- 12 volt 2-wire hookup using .180 bullet plugs; 40 lumens
- Surface mount, 4-5/8" between 2 screw holes
- IP 67 water resistant

36815	Amber LED / Amber Lens - 1 Pc. / Card
36816	Red LED / Red Lens - 1 Pc. / Card
36817	Amber LED / Clear Lens - 1 Pc. / Card
36818	Red LED / Clear Lens - 1 Pc. / Card



6 LED Chrome Door Handle Cover for Freightliner

- Chrome door handle cover with distinctive illuminated effect using 6 LED, 12VDC
- Easy installation with double sided tape
- Constructed from automotive-grade ABS plastic with quality chrome finish
- Installation tip: apply small amount of RTV silicon glue to inside four corners for a more secure fit

42489	Amber	Driver - 1 Pc. / Card
42490	Amber	Passenger - 1 Pc. / Color Box
42491	Blue	Driver - 1 Pc. / Color Box
42492	Blue	Passenger - 1 Pc. / Color Box
42493	Red	Driver - 1 Pc. / Color Box
42494	Red	Passenger - 1 Pc. / Color Box
42495	White	Driver - 1 Pc. / Color Box
42496	White	Passenger - 1 Pc. / Color Box



Stainless Steel Bullet Half Moon Headlight LED Projection

- Highly polished 304 stainless steel headlight housing and "Bullet" style bezel
- Fully assembled with LED projection headlight bulb, # 31496
- Includes top mount 4 amber LED with amber lens # 38505b
- Included housing and bezel can be purchase separately, item # 30470-1, and item # 30416

32813 Amber LED / Amber Lens Top Light - 1 Pc. / Box

32814 Amber LED / Clear Lens Top Light - 1 Pc. / Box



Stainless Steel Double Face Mirror Light Bracket with 13 LED Dual Function Lights - Amber & Red

- Highly polished 304 stainless steel finish
- Installed with 13 LED dual function reflector amber light and red light: item # 39725B, 39726B
- Perfect for mirror mounted double face lights; recommended corresponding lights: item # 38701, 39438
- 304 Stainless steel bracket available separately: # 60054B

60055 Amber LED / Amber Lens / Red LED / Red Lens - 1Pc. / Card

60056 Amber LED / Clear Lens / Red LED / Clear Lens - 1Pc. / Card

60054 Housing Only - 1 Pc. / Card



Polished Aluminum Headlight Turn Signal Cover Kit For Peterbilt

- Fits Peterbilt 357/ 365/ 367/ 378/ 379
- Covers the end of the headlight when turn signal light is not installed
- Made with quality die-cast aluminum with highly polished finish
- Kit includes: 2 headlight covers, 2 foam gaskets, 8 hex screws
- Due to variations in original factory headlight housings, it may be necessary to drill or file one of the 4 holes for best screw alignment with housing

30419 1 Pair/ Card

20 20 PCS. CONVENIENCE PACK



33mm X 2 3/4" Chrome Plastic Bullet Nut Cover W/ Flange - Push-On (20 Pack)

- Beautiful high quality chrome plated finish with triple chrome plating process
- Fits over standard 33mm lug nuts on hub piloted wheels
- Designed to cover up and hide the lug nut flange washer
- Convenience pack, includes 20 nut covers to dress up two wheels

10049 20 Pcs. / Color Box

20 20 PCS. CONVENIENCE PACK



33mm X 3 1/4" Chrome Plastic Tall Nut Cover W/ Flange - Push-On (20 Pack)

- Beautiful high quality chrome plated finish with triple chrome plating process
- Fits over standard 33mm lug nuts on hub piloted wheels
- Designed to cover up and hide the lug nut flange washer
- Convenience pack, includes 20 nut covers to dress up two wheels

10059 20 Pcs. / Color Box

10 10 PCS. CONVENIENCE PACK



33mm X 2 3/4" Chrome Plastic Original Nut Cover - Thread-On (10 Pack)

- Beautiful high quality chrome plated finish with triple chrome plating process
- Fits over standard 33mm lug nuts on hub piloted wheels
- Designed to cover up and hide the lug nut flange washer
- Convenience pack, includes 10 nut covers to dress up one wheel

10064 10 Pcs. / Color Box

10 10 PCS. CONVENIENCE PACK



1 1/2" x 4 1/8" Chrome Plastic Spike Nut Cover - Push-On (10 Pack)

- Chrome plastic spike push-on nut cover for hex nuts and bolts
- Beautiful high quality chrome plated finish with triple chrome plating process
- Fits over standard 1 1/2" lug nuts on stud piloted wheel
- Designed to cover up and hide the lug nut
- Convenience pack, includes 10 nut covers to dress up one wheel

10770 10 Pcs. / Color Box



11017



11019



Chrome Oval Emblem

- Die cast metal oval emblem w/ beautiful chrome plated finish
- 7-7/8" X 3-1/4" with mounting studs 6-1/4" apart
- Pressure sensitive adhesive tape and speed nuts included
- Dress up any vehicle

11017 Texas Edition - 1 Pc. / Card

11019 Redneck Edition - 1 Pc. / Card



11016



11018

Accent Emblem

- Beautiful chrome plated finish
- Approximately 6-3/4" wide x 1-3/4" tall
- Pre-applied pressure sensitive adhesive for easy installation on any smooth surface
- Show off your Lone Star pride!

11016 Texas Edition - 1 Pc. / Card

11018 Redneck Edition - 1 Pc. / Card



70795

70796

70797

Chrome Thread-on Gearshift Knob

- High quality die-cast aluminum with triple chrome plating
- Beautifully decorated glossy polyurethane sticker
- Inside thread 1/2"-13

70795 U.S. Flag - 1 Pc. / Card

70796 Texas Flag - 1 Pc. / Card

70797 Mexico Flag - 1 Pc. / Card



70792

70793

70794

Chrome 13/15/18 Speed Thread-on Gearshift Knob w/ Adaptor

- Fits 13/15/18 gearshift knobs
- Quality die cast metal with beautifully chrome plated finish
- Beautifully decorated glossy polyurethane sticker

70792 U.S. Flag - 1 Pc. / Card

70793 Texas Flag - 1 Pc. / Card

70794 Mexico Flag - 1 Pc. / Card



Deluxe Air Valve Knob

- Chrome deluxe aluminum air valve knob with glossy sticker, screw on
- Beautiful high quality chrome plated finish with triple chrome plating process
- Beautifully decorated glossy polyurethane sticker

23766 U.S. Flag - 1 Pc. / Card

23767 Texas Flag - 1 Pc. / Card

23768 Mexico Flag - 1 Pc. / Card



Air Valve Knob

- Chrome aluminum air valve knob with glossy sticker, screw on
- Beautiful high quality chrome plated finish with triple chrome plating process
- Beautifully decorated glossy polyurethane sticker

23769 U.S. Flag - 1 Pc. / Card

23770 Texas Flag - 1 Pc. / Card

23771 Mexico Flag - 1 Pc. / Card



3" Air Valve Knob

- 3" Chrome aluminum air valve knob with glossy sticker, screw on
- Beautiful high quality chrome plated finish with triple chrome plating process
- Beautifully decorated glossy polyurethane sticker

23772 U.S. Flag - 1 Pc. / Card

23773 Texas Flag - 1 Pc. / Card

23774 Mexico Flag - 1 Pc. / Card



1-3/4" Round Glossy Sticker

- Beautifully decorated glossy polyurethane sticker
- Approximately 1-3/4" in diameter
- Mounts with peel & stick pressure sensitive adhesive backing
- Specially designed for UP shift knob #23496, and air valve knobs #23385B & #23010-1

22941B U.S. Flag - 1 Pc. / Bulk

22942B Texas Flag - 1 Pc. / Bulk

22943B Mexico Flag - 1 Pc. / Bulk



1997-2015 Century
1979-2015 FLD120
1979-2015 Raised Roof
1979-2015 Silver Aero
1979-2015 Columbia



Windshield Sunshade For 1987-2010 Freightliner FLD120, 1996-2015 Century, 2002-2015 Columbia

- Blocks damaging UV rays & keeps interior cool
- Polyethylene bubble with reflective thermal coating
- Accordion fold and closure strap for quick & easy storage
- Includes suction cups for secure installation to windshield
- Also fits 1979-2015 models equipped with Aero Cab or raised roof configuration

98989 1 Pc. / Card



Chrome Exterior View Window Trim For 1989-2009 Freightliner FLD, 1989-2010 Classic - Includes Adhesive

- Beautiful high quality chrome plated finish with triple chrome plating process
- Sealant adhesive included for easy installation

40946 1 Set / Card



Windshield Sunshade for 2013-2019 Kenworth T680

- Blocks damaging UV rays & keeps interior cool
- Polyethylene bubble with reflective thermal coating
- Accordion fold and closure strap for quick & easy storage
- Includes suction cups for secure installation to windshield

98993 1 Pc. / Card



United Pacific Cap - Camo U.P. Cap

- 100% cotton twill cap

99086 1 Pc. / Bulk

NEW ITEMS

September 2020



39161

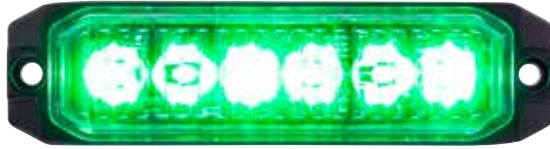

39163



39162



39164



39165

COMPETITION SERIES

6 High Power LED "Competition Series" Slim Warning Light

- 6 high power LED's with 11 flash patterns, selectable for synchronized and alternating
- Slim profile and surface mounted for easy installation
- Rugged cast aluminum construction resists corrosion and vibration. IP67 rating
- 12VDC-24VDC



39161	Amber LED - 1 Pc. / Color Box
39162	Blue LED - 1 Pc. / Color Box
39163	Green LED - 1 Pc. / Color Box
39164	Red LED - 1 Pc. / Color Box
39165	White LED - 1 Pc. / Color Box



36743B

36744B

36745B



1 LED Mini Clearance Light with Rubber Grommet

- 1 SMD LED mini marker light with rubber grommet
- Polycarbonate lens sonically sealed to housing to prevent moisture intrusion
- Requires 3/4" diameter hole for installation
- Lifetime warranty

36743B	Amber LED / Amber Lens - 1 Pc. / Bulk
36744B	Red LED / Red Lens - 1 Pc. / Card
36745B	Amber LED / Clear Lens - 1 Pc. / Card



Matte Black Bassett Hound Ornament

- Detailed die-casting with powder coated matte black finish
- Easy installation on any vehicle with four mounting studs
- Approximately 7-5/8" x 4-1/8" x 7-1/4"
- Mounting hardware included
- Perfect decorator item for home, office and man cave

72053	Black - 1 Pc. / Color Box
--------------	----------------------------------



42849

42826

Mirror Assembly With LED Turn Signal For 2012-2017 Volvo VNL

- OE style replacement mirror with power adjustable mirror, heated glass, LED turn signal and antenna connector
- Includes complete mirror and mounting arm with black back cover

42848 (New)	Black	Driver - 1 Pc. / Box
42849 (New)	Black	Passenger - 1 Pc. / Box
42825	Chrome	Driver - 1 Pc. / Box
42826	Chrome	Passenger - 1 Pc. / Box

20 PCS. CONVENIENCE PACK



1 1/2" X 2 3/4" Chrome Plastic Bullet Nut Cover - Push-On (20 Pack)

- Chrome plastic bullet push-on nut cover for hex nuts and bolts
- Beautiful high quality chrome plated finish with triple chrome plating process
- Fits over standard 1-1/2" lug nuts on stud piloted wheel
- Designed to cover up and hide the lug nut
- Convenience pack, includes 20 nut covers to dress up two wheels

10047 20 Pcs. / Color Box



1985-1992	K100
1986-2003	T600
1986-2003	T800
1983-2005	W990

Small Gauge Cover W/ Visor For Kenworth

- Beautiful high quality chrome plated plastic gauge bezel w/ visor
- Fits 2-5/16" diameter gauges
- Inside opening diameter 1-5/8". Exterior diameter 2-7/16"

20531 1 Pc. / Card

NEW ITEMS

October 2020



Projection Headlight With LED Sequential Turn And DRL For Peterbilt 386/387

- Quality chrome plated inner housing with projector type light design
- Features 18 LED DRL/position light and 24 LED sequential turn signal
- Easy connection, plugs into existing harness
- SAE/DOT, FMVSS108
- Fits: Peterbilt 382 2007-2018, Peterbilt 384 2007-2014, Peterbilt 386 2005-2015, Peterbilt 387 1999-2010
- Sold individually, please specify driver or passenger side

35765	Chrome	Driver - 1 Pc. / Color Box
35766	Chrome	Passenger - 1 Pc. / Color Box
35767	Blackout	Driver - 1 Pc. / Color Box
35768	Blackout	Passenger - 1 Pc. / Color Box

DOT

Technical Specification	
Low Beam Application	High Beam Application
H7 quartz halogen bulb	H7 quartz halogen bulb
4.58 amps/55 watt	4.58 amps/55 watt
12V	12V



DOT

High Power LED Fog Light For 2018-2020 Freightliner New Cascadia

- Fits 2018+ Freightliner Cascadia
- Direct replacement for trucks originally equipped
- Easy connection, plugs into existing wiring harness
- SAE/DOT, FMVSS108
- 800 Lumens, 12VDC
- Sold individually, please specify driver or passenger side



32598	Chrome	Driver - 1 Pc. / Color Box
32599	Chrome	Passenger - 1 Pc. / Color Box
32898	Blackout	Driver - 1 Pc. / Color Box
32899	Blackout	Passenger - 1 Pc. / Color Box

20 PCS. CONVENIENCE PACK



1-1/2" X 2-3/4" Chrome Plastic Bullet Nut Cover - Push-On (Color Box of 20)

- Beautiful high quality chrome plated finish with triple chrome plating process
- Fits over standard 1-1/2" lug nuts on stud piloted wheel
- Designed to cover up and hide the lug nut
- Convenience pack, includes 20 nut covers to dress up two wheels

10045 20 Pcs. / Color Box

20 PCS. CONVENIENCE PACK



1-1/2" X 2-3/4" Chrome Plastic Bullet Nut Cover W/ Flange - Push-On (Color Box of 20)

- Beautiful high quality chrome plated finish with triple chrome plating process
- Fits over standard 1-1/2" lug nuts on stud piloted wheel
- Designed to cover up and hide the lug nut
- Convenience pack, includes 20 nut covers to dress up two wheels

10046 20 Pcs. / Color Box

20 PCS. CONVENIENCE PACK



1-1/2" X 2-3/4" Chrome Plastic Tall Nut Cover - Push-On (Color Box of 20)

- Beautiful high quality chrome plated finish with triple chrome plating process
- Fits over standard 1-1/2" lug nuts on stud piloted wheel
- Designed to cover up and hide the lug nut
- Convenience pack, includes 20 nut covers to dress up two wheels

10084 20 Pcs. / Color Box



Black Front Axle Cover With Dome Cap & 1-1/2" Nut Covers - Push-On

- Fits most 20", 22-1/2" and 24-1/2" wheels with 11-1/4" bolt circle/center applications
- High quality injection molded plastic in matte black finish
- Removable hub cap for easy inspection of axle
- Made of high-impact plastic, light-weight, and corrosion resistant
- Includes 1 cover, 1 cap, and 10 nut covers per kit. Kit also includes 2 metal washers

10348 1 Set / Color Box



Upper Sleeper Fairing For 2008-2017 Freightliner Cascadia

- High quality extender fairing extends from the back outer edges of the sleeper
- Molded from OE spec materials including threaded brass inserts and threaded mounting posts
- Mounting bracket, mounting hardware, and air deflector not included
- Sold individually, please specify driver or passenger side
- OEM number A22-67507-000, A22-67507-001

42853 Driver - 1 Pc. / Box

42854 Passenger - 1 Pc. / Box



Lower Sleeper Fairing For 2008-2017 Freightliner Cascadia

- High quality extender fairing extends from the back outer edges of the sleeper
- Molded from OE spec materials including threaded brass inserts and threaded mounting posts
- Mounting bracket, mounting hardware, and air deflector not included
- Sold individually, please specify driver or passenger side
- OEM number A22-67506-004, A22-67506-005

42851 Driver - 1 Pc. / Box

42852 Passenger - 1 Pc. / Box



Bumper Cover For 2017+ International LT

- Corner bumper cover for 2017+ International LT
- Sold individually, please specify driver or passenger side
- OEM number 4057028C2, 4057029C2

21943 Driver - 1 Pc. / Box

21944 Passenger - 1 Pc. / Box



Narrow Grille For 2015-2020 Isuzu NPR (ELF 200/300)

- White painted ABS plastic with black grille opening accent
- Mounting clips pre-installed for easy installation
- Overall dimension: 43"l x 11"w x 2"h
- OEM No. 8-98241-071

21822 1 Pc. / Box



Stainless Steel Large Paddle Switch Plate for International

- Quality die stamped polished stainless steel
- Easy installation with included 2-sided tape
- Fits various International models and years

48156 1 Pc. / Card



Stainless Steel Small Paddle Switch Plate for International

- Quality die stamped polished stainless steel
- Easy installation with included 2-sided tape
- Fits various International models and years

48157 1 Pc. / Card



Chrome Switch Cover For Kenworth T680, T880 & W990 (Card of 3)

- Beautiful high quality chrome plated finish with triple chrome plating process
- Double sided tape on back for easy installation

41452 3 Pcs. / Card



70601B **70622B** **70644B** **70645B**

Chrome Grip

- Chrome aluminum grip, CNC machined grip
- 1" round opening, hex screw mount
- Mounting adaptor item # 70600b and 70604b available separately

70601B Daytona - 1 Pc. / Bulk

70622B Dallas - 1 Pc. / Bulk

70644B Brooklyn - 1 Pc. / Bulk

70645B Austin - 1 Pc. / Bulk



Dash Hook For 2008-2017 Freightliner Cascadia

- Chrome plastic dash hook for first generation body style Freightliner Cascadia
- Installation requires the OEM hook to be unscrewed from the back side of the dash
- Do not attempt to pull the OEM hook out from the front

42309 1 Pc. / Card



4" Chrome Off Road Halogen Light W/ Clear Lens

- Super bright halogen, shock absorbing rim and mounting bracket
- Reinforced chrome metal housing, stainless steel wire loom
- Includes 12V 55W H3 halogen bulb

30614 1 Pc. / Color Box



15 LED 3" Reflector Double Face Light

- Double Face 3" Auxiliary Reflector Light
- 15 Amber LED with 5 Red LED, Single Function
- Heavy Duty Chrome Housing (UP Item # 30568-1), Single Stud Mounting
- For Auxiliary/Utility Light Applications, 2 Wires (Hard Wired)

39565 Amber LED Amber Lens/Red LED, Red Lens - 1 Pc. / Card

39566 Amber LED Clear Lens/Red LED, Clear Lens - 1 Pc. / Card



United Pacific Work Light Display

- Includes 36514, 36515, 37088, 37123, 37157, 37597
- Attractive counter top display with interactive push buttons
- Ready to use, requires 110V outlet
- Display approximate size: 21-5/8" L X 19-5/8" W X 9-7/8" H

99074 1 Pc. / Box



Chrome Skull Shift Linkage For Harley

- Unique 3D skull design with triple chrome plating for a lasting show-bike shine
- High quality adjustable rod end ball joints to ensure smooth operation
- Includes a straight transmission lever cover and decorative acorn nuts and bolts. (Note: cover does not fit 2017+ Milwaukee-Eight with curved trans lever)
- Complete the look with Skull Swing Arm Insert Set, UP item # 52010
- Fits 1986+Harley Softtail (except 18+ FXBB and FXLR), Touring and Trike models. (Does not fit 97- 99 FLSTS or models equipped with Softail Extended Reach Forward Controls)

52009 1 Pc. / Card



Chrome Skull Swing Arm Accent Set For Harley

- Fits 2008-17 Harley-Davidson Softail models (except FXCW, FXCWC, FXSB, and FXSBSE)
- Unique four-piece skull accent set to dress up the recessed area in the rear swing arm frame
- Easy to install with pressure sensitive adhesive mounting
- Beautifully chrome plated plastic injection molded
- Add a little attitude to your ride

52010 1 Set / Card

NEW ITEMS

November 2020

Heated LED Headlights with Polycarbonate Lens & Housing

Available Mid-November



- Features a heating system that automatically de-ices and defrosts the headlight lens when outside temperature reaches 50 degrees Fahrenheit (10 Celsius) or below
- Integrated monitoring system to turn off heating when snow & ice has cleared from lens
- Durable corrosion resistant polycarbonate lens, housing & electronics resist shock and vibration
- Plug & play with standard H4 style connector plug for ease of installation





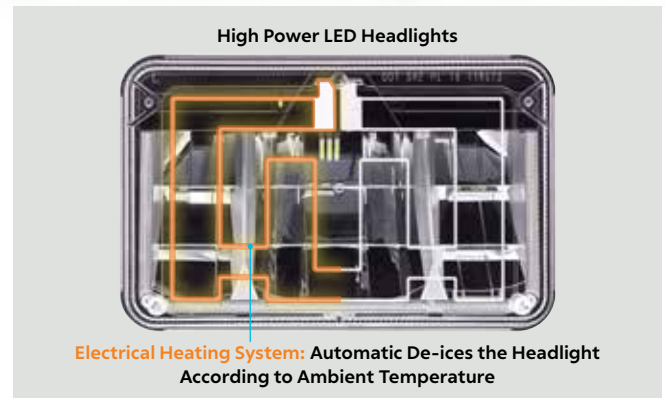

100%LED

DOT



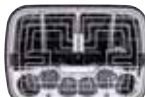



Technical Specs

	Item	Size	Beam	Lumens	Color Temp.	Voltage	Unit / Box
	34135	4" x 6"	Low	750	6500 kelvin	12v/24v	1 Pc. / Card
	34136	4" x 6"	High	1000	6500 kelvin	12v/24v	1 Pc. / Card
	34137	5" x 7"	High/Low	1100/600	6000 kelvin	12v/24v	1 Pc. / Card
	34138	7"	High/Low	950/500	5700 kelvin	12v/24v	1 Pc. / Card

Also Available:

Technical Specs

	Item	Size / Color	Beam	Lumens	Watts	Voltage	Unit / Box
	34131	4" x 6" / Chrome	Low	1000	20	12v/24v	1 Pc. / Color Box
	34132	4" x 6" / Chrome	High	1200	24	12v/24v	1 Pc. / Color Box
	34133	4" x 6" / Black	Low	1000	20	12v/24v	1 Pc. / Color Box
	34134	4" x 6" / Black	High	1200	24	12v/24v	1 Pc. / Color Box



42845



42847



Chrome Hood Mirror With Heated Lens For 2018-2020 Freightliner Cascadia

- High quality heated mirror assembly with beautiful chrome plated mirror cover
- Complete hood mirror, includes mounting arm, backing plate and hardware
- Sold individually, please specify driver (A2273566002) or passenger side (A2273566003)

42844	Chrome	Driver - 1 Pc. / Box
42845	Chrome	Passenger - 1 Pc. / Box
42846	Blackout	Driver - 1 Pc. / Box
42847	Blackout	Passenger - 1 Pc. / Box

20 PCS. CONVENIENCE PACK



33mm X 3 3/16" Chrome Plastic Pointed Nut Cover W/ Flange - Push-On (Color Box of 20)

- Chrome plastic pointed push-on nut cover for hex nuts and bolts
- Beautiful high quality chrome plated finish with triple chrome plating process
- Fits over standard 33mm lug nuts on hub piloted wheels
- Designed to cover up and hide the lug nut flange washer
- Convenience pack, includes 20 nut covers to dress up two wheels

10117 20 Pcs. / Color Box



Axle Cover With Dome Cap & 1-1/2" Nut Covers - Push-On

- Fits most 20", 22-1/2" and 24-1/2" wheels with 11-1/4" bolt circle/center applications
- High quality injection molded plastic in chrome or matte black finish
- Removable hub cap for easy inspection of axle
- Made of high-impact plastic, light-weight, and corrosion resistant
- Includes 1 cover, 1 cap, and 10 nut covers per kit. Kit also includes 2 metal washers

10347 Chrome - 1 Set / Color Box (New)

10348 Black - 1 Set / Color Box



Center Bumper Inner Reinforcement With OnGuard Cutout For 2008-2017 Freightliner Cascadia

- Quality heavy duty injection molded plastic with original features for simple and quick replacement
- Features center cut-out for OnGuard radar unit and tow hook receiver pass-thru holes
- Includes OE spec clip-on nuts for corner reinforcements installation
- OEM number 21-28443-014

42855 1 Pc. / Box

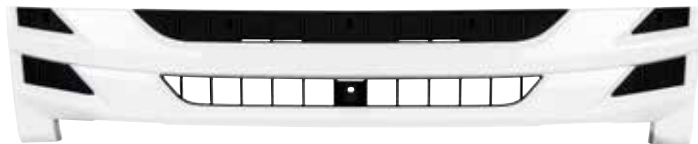

Wide Grille For 2013+ Isuzu NPR (ELF 400/500/600)

- White painted ABS plastic with black grille opening accent
- Mounting clips pre-installed for easy installation
- Overall dimension: 52"l x 11"w x 2"h
- OEM No. 8-98244-209-1

21821 1 Pc. / Box



Chrome Emergency Tone Horn

- Chrome emergency tone horn, 6" diameter trumpet
- Replicates the sound of fire trucks and other emergency vehicles
- Heavy duty construction with trumpet support bracket
- Includes brass 1/8" NPT male compression 1/4" air hose fitting, and mounting hardware
- Optional electric solenoid can be fitted to existing 1/4" NPT threaded inlet. Solenoid sold separately, item # 46127-4. NOTE: original 1/8" NPT inlet will be plugged

46174 1 Pc. / Color Box



Highly Detailed Bassett Hound Ornament

- Detailed die-casting with beautiful chrome plating or matte black powder coated finish
- Easy installation on any vehicle with four mounting studs
- Approximately 7-5/8" x 4-1/8" x 7-1/4"
- Mounting hardware included
- Ideal for decorating small and personal space, home, office and garage

72003 Chrome - 1 Pc. / Color Box

72053 Black - 1 Pc. / Color Box



19" Double Contact Pigtail

- 18 AWG thermoplastic jacketed wires
- Tinned copper wires for better corrosion resistance
- Nylon insulation plate

A1060-4 1 Pc. / Bulk

NEW ITEMS

December 2020



12 LED Cab Light For 2008-2017 Freightliner Cascadia - Amber LED/Amber Lens

- 12 LED cab light for first generation body style Freightliner Cascadia
- Polycarbonate lens sonically sealed to housing to prevent moisture intrusion
- Amber LED with amber lens
- 2 wires (hard wired)
- Also fits 2018+ new generation Cascadia without any modification

39212 1 Pc. / Card



8 LED Mid-Trailer Turn Signal Light - Amber LED/Amber Lens

- 8 amber SMD LED mid-trailer turn signal light
- Polycarbonate lens sonically sealed to housing to prevent moisture intrusion
- Amber LED with amber lens
- 3 contact female terminal
- Recommended plug: item # 34212/34216

38922 1 Pc. / Card

38922B 1 Pc. / Bulk



Bumper End Cover Without Fog Light Hole For 2008-2017 Freightliner Cascadia -Passenger (Box Of 5)

- Original style reproduction without fog light hole
- Precision punched mounting holes for inner reinforcement
- OEM number: 21-27300-001, 21-27300-009
- Inner reinforcement available separately, item # 20894
- Passenger side application
- Sold in quantity of 5, nested in single box

20847M5 5 Pcs. / Box



Bumper Inner Reinforcement For 2017-2020 International LT

- High quality reproduction with original spec strength reinforcing designs and contour
- Features 3 heavy duty riveted mounting plates with welded nuts and stud
- Includes clip-on nuts for straight forward bumper skin installation
- OEM number 4058383C2 (driver) & 4058384C2 (passenger)
- Sold individually, please specify driver or passenger side

21945 Driver - 1 Pc. / Box

21946 Passenger - 1 Pc. / Box



Complete 3-Piece Front Bumper Set For 2008-2017 Freightliner Cascadia

- High quality plastic injection molded with OE spec detail and strengthening features
- Bumper covers and inner reinforcements ship pre-assembled from factory
- Heavy duty steel mounting plates for direct bolt-on installation to truck frame
- OE style retaining tabs for securing the bumper ends to the bumper center
- Bumper center features cut-out for OnGuard radar unit and tow hook receiver pass-thru holes
- 6 additional screws and washers included for connecting the 3 pieces together at the bottom
- Available with or without fog light opening
- Bumper to truck frame mounting bolts not included
- Direct replacement for OE part: A21-28546-052 (with fog) & A21-28546-054 (without fog)

21947 Without Fog Light - 1 Set / Box

21948 With Fog Light - 1 Set / Box



21950

21949

Polymer Quarter Fender For 2018-2021 Freightliner Cascadia

- Quality polymer reproduction with OE specification
- Features one-piece design with sleeve that slips over the truck quarter fender post, no additional mounting bracket needed
- Strengthening ribs on inner side of the fender to help maintain shape and structural integrity
- Black color finish
- Mounting clamp not included
- Sold individually, please specify driver or passenger side
- Direct replacement for OE part: A22-75774-000 (Driver) & A22-75774-001 (Passenger)

21949 Driver - 1 Pc. / Box

21950 Passenger - 1 Pc. / Box

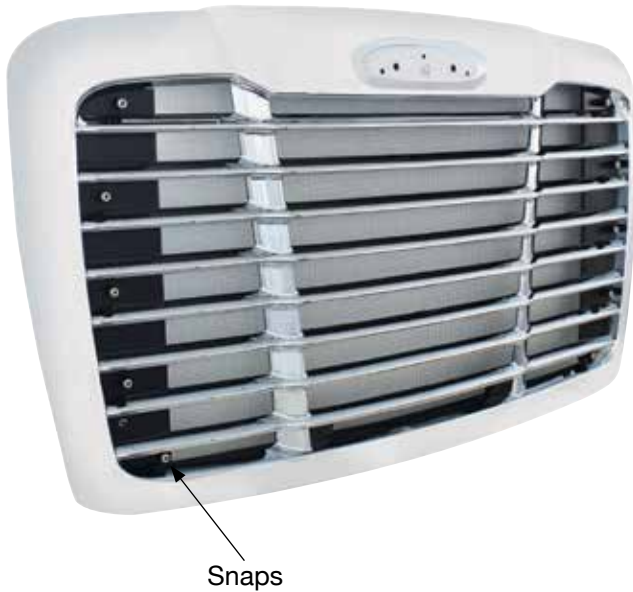

Snaps

Winter Guard Edition Chrome Grille w/Bug Screen For 2008-2017 Freightliner Cascadia

- Chrome grill with bug screen for first generation body style Freightliner Cascadia winter guard edition trucks
- Includes 10 snaps for application of vinyl winter guard
- White vinyl winter guard sold separately: item # 21149
- Approximately 57 3/4" l X 34" w

21150 1 Pc. / Box



White Vinyl Front Winter Guard For 2008-2017 Freightliner Cascadia

- Front winter guard for first generation body style Freightliner Cascadia
- 6 slot winter front guard
- Fits grill: item # 21150

21149 1 Pc. / Box

20 PCS. CONVENIENCE PACK



1 1/2" X 2 1/4" Chrome Plastic Standard Nut Cover - Push-On (Color Box Of 20)

- High quality chrome finish for durability & shine
- Fits over standard 1-1/2" lug nuts on stud piloted wheels
- Designed to cover up and hide the lug nut
- Convenience pack, includes 20 nut covers to dress up two wheels

10057 20 Pcs. / Color Box

20 PCS. CONVENIENCE PACK



33mm X 2-3/4" Chrome Plastic Amber Reflector Nut Cover W/ Flange - Push-On (Box Of 20)

- Beautiful high quality chrome plated finish with triple chrome plating process
- Fits over standard 33mm lug nuts on hub piloted wheels
- Designed to cover up and hide the lug nut flange washer
- Reflector available in amber, red, and blue
- Convenience pack, includes 20 nut covers to dress up two wheels

10070 20 Pcs. / Color Box

10 PCS. CONVENIENCE PACK



33mm x 4 1/2" Chrome Plastic X Spike Nut Cover - Thread-On (Box of 10)

- Beautiful high quality chrome plated finish with triple chrome plating process
- Fits over standard 33mm lug nuts on hub piloted wheels
- Designed to cover up and hide the lug nut flange washer
- Convenience pack, includes 10 nut covers to dress up one wheel

10780 10 Pcs. / Color Box



Chrome Steel Lower Gearshift Knob Cover

- Exceptional quality stamped steel and beautifully chrome plated
- Fits Eaton Fuller style 9/10/13/15/18 speed shifters

41069 1 Pcs. / Card



Chrome Plastic Rocker Switch Cover For Peterbilt - Axle Differential

- Beautiful high quality chrome plated finish with triple chrome plating process
- Fits various Peterbilt years and models

40970 1 Pcs. / Card



Chrome Plastic Rocker Switch Cover For Peterbilt - Fifth Wheel

- Beautiful high quality chrome plated finish with triple chrome plating process
- Fits various Peterbilt years and models

40971 1 Pcs. / Card



Climate control unit shown for display only

Chrome A/C Knob For Kenworth T680/T880 Sleeper

- Durable plastic with beautiful chrome plated finish
- Knob can be use on fan speed control or temperature control
- Feature metal sleeve inside the mounting hole help secure knob onto the A/C control stem
- For easy installation, use of non-marking plastic pry tool is recommended, U.P. item# 99135
- Sold each with store-ready retail packaging
- Climate control unit shown for display only

41451 1 Pcs. / Card



Air Pressure Switch

- Air pressure switch turns on the compressor when tank pressure is below 85 psi and turns off the compressor when tank is 105 psi
- 1/8" male pipe threads, 1/4" push on male terminals
- 150 PSI Max
- Direct replacement for our heavy duty compressor kit, 46154

46126 1 Pcs. / Card



90089

90023

90066

Red Treated Airway Buff - 5/8" & 1/2" Arbor

- Double dipped in d-50 treatment for toughness
- These extra hard buffs are perfect for heavy cutting and polishing
- 12 ply. 5/8" & 1/2" arbor
- Cloth is biased cut to ensure maximum life
- For use on aluminum, brass, copper, die-cast, and stainless steel
- Available in 3 different diameters, 6", 8" or 10"

90066 6" - 1 Pc. / Bulk

90023 8" - 1 Pc. / Bulk

90089 10" - 1 Pc. / Bulk

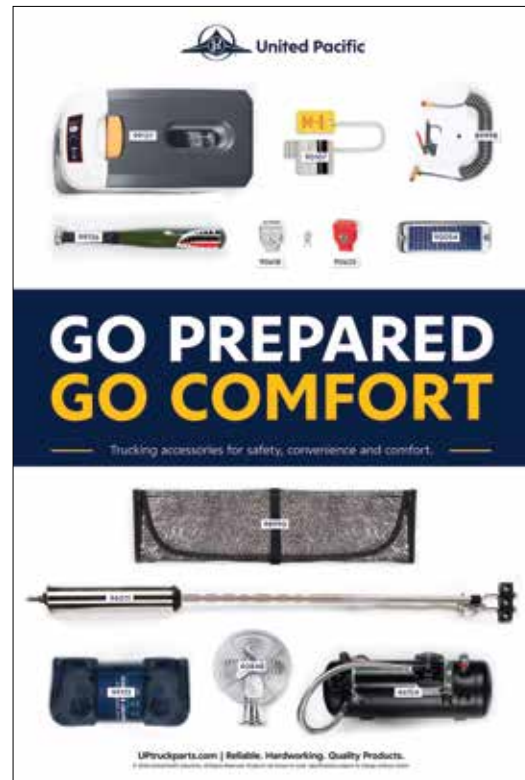

Poster Of United Pacific Driver Comfort

99206 1 Pcs. / Bulk

TERMS & CONDITIONS / ORDERING GUIDELINES / FREIGHT

IMPORTANT: PLEASE REVIEW CAREFULLY

New Accounts

Initial minimum buy-in is \$2,000 (or to be determined by United Pacific Industries, UPI hereafter). All initial orders must be prepaid in advance by Cashier's Check or VISA/MC. All new/potential accounts must complete a UPI "New Customer Info/Credit Form" and follow the Dealer Qualification Instructions. Upon completion of the credit application, approved accounts will be assigned payment terms of NET 30 Days (from invoice date). Accounts denied a credit line will be required to prepay in advance by Cashier's Check or VISA/MC.

Payment Terms

Term Accounts: Accounts with NET 30 Days terms are required to submit payment within the 30 days from the date of invoice. Acceptable forms of payment include checks, ACH (Automated Clearing House), or wire transfer.

A service charge of 1.5% per month will be imposed on invoices not paid within the 30 day term. Delinquent accounts will be required to pay Cash-In-Advance (CIA). Checks will be accepted but orders will not be released until the check is cleared by the bank. Past due invoices will delay current orders. Please check with UPI on your account status when placing an order.

Credit Cards

Accounts denied credit terms may pay by Visa or MasterCard. Credit card will be charged upon shipment. Credit card payments will not be accepted once an order has been shipped. UPI does not accept American Express or Discover card.

COD

A \$9.00 fee will be assessed per COD box for all FedEx/UPS COD shipments. Truck COD shipment fees are to be determined later by trucking company.

Returned Checks

A \$30 NSF (Non Sufficient Fund) fee will be assessed on each incidence a check is returned to UPI.

Ordering Guidelines

Placing Orders

New orders may be placed by any of the following methods

- Dealer Portal
- Email: returns@upauto.com
- Fax : (888) 986-5988

Telephone: In order to minimize errors, customers are encouraged to submit their orders by fax or mail. Telephone orders should be limited to smaller orders such as add-ons to orders already submitted and/or fill-ins occurring between larger restocking orders.

Changes to Orders

Initial minimum buy-in is \$2,000 (or to be determined by United Pacific Industries, UPI hereafter). All initial orders must be prepaid in advance by Cashier's Check or VISA/MC. All new/potential accounts must complete a UPI "New Customer Info/Credit Form" and follow the Dealer Qualification Instructions. Upon completion of the credit application, approved accounts will be assigned payment terms of NET 30 Days (from invoice date). Accounts denied a credit line will be required to prepay in advance by Cashier's Check or VISA/MC.

Canceling Orders

Cancellation of orders must be submitted via fax or email within 24 hours of the order date. If the order has already shipped it will be the customers responsibility to return the order at the customers own expense. A restocking fee may apply, please see "Return" policy for further detail.

Backorders

Customers have the option of having their backorders shipped or cancelled. UPI will notify customer as to availability of backorders and will be able to ship any backorder items customer still needs as part of their next stock order. UPI reserves the right to cancel backorders that are 6 month or older from invoice date.

Minimum Order

A minimum order of \$50.00 is required. Orders below \$50.00 will be assessed a minimum order fee of \$10.00.

Packaging

A 10% service charge will be added to orders with special packaging or UPC barcoding requirements.

Lead Times

Standard lead time for all United Pacific orders is 1-3 business days from the receipt of the purchase order. Larger orders may require a lead time of up to 5 business days. Transit time of 3-5 business days must be considered when placing orders. UPI cannot be responsible for delays in shipment after an order leaves our warehouse. UPI will work to resolve delays with freight forwarding firms, however, delays do arise from time to time due to weather and unforeseen circumstances beyond UPI's control. Express order are exempted; please view Freight/Shipping Policy for further detail.

Order Confirmation

United Pacific will acknowledge receipt of orders by email/fax/ telephone within 1 business day of receipt. If confirmation is not received, please contact UPI to ensure your order was received.

Freight

Prepaid Freight

Stock orders between \$50 and \$1,299.99 (US Lower 48 States and Canada), \$50 and \$2799.99 (Alaska and Hawaii), [all price net US\$], will be shipped FOB Long Beach, California. Stock orders of \$1,300.00 (US Lower 48 States and Canada), \$2800.00 (Alaska and Hawaii), [based on UPI current pricing], or more will be shipped Freight Prepaid Ground to a single location only. Exclusions on prepaid: 1) Grille Guard (item# 80000) will always ship FOB Long Beach. 2) Express NDA and 2-day orders, Special Net Pricing orders, and Special Quote Pricing orders ship FOB Long Beach. United Pacific reserves the right to select the carrier of our choice. Customer may select the carrier of their choice at their own expense, negotiated rates and insurance. UP cannot be held responsible for shipping loss or damage if customer selects their own carrier. If customer elects to choose their own freight carrier, orders will be shipped via FREIGHT COLLECT:

Will Call Orders

Will Call orders can be picked up 2 - 4 hours after placing the order. Customers should always call ahead to confirm when order will be ready to pick up.

Shipping Policy

International Shipments

Shipments to locations outside the continental United States will be shipped to the customer's shipping agent or broker within the continental United States in accordance with the US freight policy. International customers will be responsible for the duties and taxes of their respective country.

SHIPPING POLICY / CLAIMS

IMPORTANT: PLEASE REVIEW CAREFULLY

Express Orders

All express orders, such as Next Day, Second Day, 3 Day Service & Will Call, must be faxed/emailed. Order confirmation will be faxed to the customer for final approval. If confirmation is not received, please contact UPI to ensure your order was received. Customers are required to sign off on express orders and fax confirmation back to UPI. Cut off for express order is 12:00PM. Express orders received after 12:00PM may or may not ship the same day. Please call UPI to confirm projected shipping date or will call time. Due to the high cost of express shipments, customer may request UPI to call to confirm freight charges. If customer does not request confirmation, UPI will ship the express order.

Drop Shipments

All drop shipment orders will be assessed a 5% processing fee. Drop shipment processing fee will be automatically added to the invoice without notice. All drop shipment orders must be faxed in. No freight allowance or prepaid freight will be permitted for any drop shipments, thus, all drop ship orders, regardless of order size, are FOB Long Beach, CA.

Claims

General Policy

All claims (Shortage, Mis-Shipped, Damage, Overage, Customer Error & Billing Error) must be submitted to UPI within 3 business days of the receipt of shipment. Claims submitted beyond 3 business days of the receipt of shipment will be voided by UPI.

On all shipments, the person who signs and receives the shipment is responsible for noting on the Bill of Lading, in writing, whether any boxes arrived damaged or shorted. Failure to do so will void all claim rights between all parties. UPI will have no recourse against the trucking company if customer does not note any damages or shortages on the Bill of Lading.

The customers receiving department must count and sign for the exact number of boxes received. Failure to follow the above instructions will void all claim rights between all parties.

Shortages / Mis-Ships / Damages

While UPI strives to fill every order with 100% accuracy, on occasion an item may get shipped in error or get damaged during shipping. In the event this occurs, please follow the process below. Note: This type of claim must be reported to UPI within three (3) business days of receiving the order.

1. Contact the United Pacific office to initiate the claim. To make it easy for you we have two acceptable methods for requesting the claim:

- Email: returns@upauto.com
- Fax : (888) 986-5988

Note: To ensure you receive a timely credit, we cannot accept claim requests by phone.

2. You will be required to provide the following information:

- Your business name
- Contact name and telephone number (in case we have questions)
- Date the order was received
- A copy of the Packing List / Invoice noting the item number and quantity that was shipped in error or damaged during shipping.
- Special instructions you have for us.

3. UPI will send a return label so you can ship the items back.

4. Once we receive the miss-shipped/damaged item(s) a credit will be issued to your account on the next billing cycle.
5. Shortages will be credit to the Customers' account, unless customer would like the shortages replaced.

Overages

UPI strives to provide our customers with the best customer service and products, in turn we would greatly appreciate any help from customer in notifying UPI of any shipping overages. Customers will be offered the option of retaining the merchandise or returning the merchandise to UPI at UPI's expense. If the items are to be returned, an RMA number and return shipping label will be provided.

Customer Errors

Any item or quantity ordered in error by the customer may be returned by contacting UPI for a RMA number.

1. To make it easy for you we have two acceptable methods for requesting the RMA:

- Email: returns@upauto.com
- Fax : (888) 986-5988

Note: To ensure you receive a timely credit, we cannot accept claim requests by phone.

2. You will be required to provide the following information.

- Your business name
- Contact name and telephone number (in case we have questions)
- A list of the items number and quantity ordered in error
- Special instructions you have for us

3. UPI will review the request to ensure the products are within the return period.

4. Once we have validated the request, United Pacific will issue an RMA number to the customer. In issuing the RMA approval, the following conditions will apply:

- Returned items are subject to a 20% re-stocking fee.
- Return shipping costs are the responsibility of the customer.
- Items must not have any retail/price sticker on exterior packaging or they will be returned to the customer at customer's expense and no credit given.
- Items must be in good condition with original packaging intact or they will be returned to the customer at customer's expense and no credit given.
- Allow up to 30 days for the credit to be issued from the time the returned items are received.

Billing Errors

Billing errors should be reported to UPI within 3 business days of invoice receipt. Customers are asked to provide the invoice number, part number, and quantities in question. Once verified, UPI will issue a credit or an invoice for the difference in billing error. provided.

WARRANTY POLICY / RETURNS

IMPORTANT: PLEASE REVIEW CAREFULLY

Warranty Policy

General Policy

UPI offers a NO HASSLE WARRANTY RETURN policy. Warranty claims can only be submitted through an authorized UPI Distributor. UPI warranty is not transferable and applies to the original installation and purchase only.

In no event shall UPI be liable for incidental or consequential damages, nor shall UPI be liable for any claims or damages arising out of or connected with the UPI warranty which exceed the purchase price of the products.

There are no warranties, expressed or implied (including any warranty of merchantability or fitness) that extend beyond this warranty. The warranty does not apply to costs associated with the loss of use of the product, loss of time, inconvenience, commercial loss, incidental or consequential damages. The warranty does not apply to products which are damaged or made defective by faulty or incorrect installation. UPI reserves the right to alter the designs of products without assuming any obligation to modify previously manufactured products and will only replace warranted products with redesigned products.

Aluminum / Chrome / Stainless Steel Products

Aluminum, chrome, and stainless steel products carry either a limited 6 month warranty, or a limited 1 year warranty (from invoice date) against defects in material or workmanship. Check the product page on our website for specific warranty period.

All Grill Guards (Item # 80000): A) Stainless Steel Materials and factory workmanship of the product itself carry a Limited Lifetime warranty. B) The Stainless steel polish and finish has a 12 month warranty. C) This warranty is provided only to the original purchaser/consumer, and on the original installation. Warranty is not transferable. Product failure or breakage due to accident/wreck or improper installation is not covered.

All mounting kits (Item # 80001, 80002, 80003, 80004, 80005): A) Steel Materials and factory workmanship on the sub-assembly bracket are Lifetime warranty. B) The painted or zinc finish has a 12 month warranty. C) Any ancillary components and parts (e.g. washers, bolts, spacers, etc.) which are not part of the sub-assembly, carry a 12 month warranty. D) This Warranty is provided only to the original purchaser/consumer, and on the original installation. Warranty is not transferable. Product failure or breakage due to accident/wreck or improper installation is not covered.

Lighting Products

Incandescent Lighting:

All incandescent lighting products carry a limited 12 month warranty (from invoice date) against defects in material or workmanship. The limited 12 month warranty does not apply to several applications, such as, buses, construction equipment, and off road vehicles.

LED Lighting:

All LED lighting products carry a specific Limited Warranty (from invoice date) against defects in material or workmanship.

- LED with vehicle specific application is limited lifetime warranty to an original purchaser with receipt. Examples of lifetime warranty product: CTL5720LED CTL5720LED for 1957 Chevy, FTL3201LED-L for 1932 Ford.

- LED Marker, 2", 2-1/2", 4", 7", Oval & Square Lights - Varies from 2 years to 10 years to Limited Lifetime, depending on specific item. The housing, bezel or mounting base on any light made from Chrome/Stainless carries a 6 month limited warranty.
- LED Cab Lights and Kits, Double/Single Stud Turn Signal and PB/KW/FL/VL or non-make Turn Signals and any/all Strip Lights - Varies from 2 years to 10 years to Limited Lifetime, depending on specific item. The housing, bezel or mounting base on any light made from Chrome/Stainless carries a 6 month limited warranty.
- LED Beacon, Driving, Headlights, Work & Warning Lights - Varies from 6 months to 3 years. The housing, bezel or mounting base on any light made from Chrome/Stainless carries a 6 month limited warranty.
- All LED Accessory Lights (Honda, Stainless Steel Double/Single face Lights, Interior Lights, License Plate Lights, and any Accent Lights. The housing, bezel or mounting base on any light made from Chrome/Stainless carries a 6 month limited warranty.

Returns

General Policy

All returns must be authorized by UPI. All return requests must be faxed or e-mailed (returns@upauto.com). A RMA number (Return Merchandise Authorization Number) will be provided. Returns not possessing a valid RMA number are subject to rejection and will be returned to sender at the customer's expense.

All customers are encouraged to use the Warranty RMA Claim Form and Dealer Portal Dashboard.

Defective Goods / Warranty Return

UPI offers our customers a No Hassle Warranty Return. Please follow the instructions below for requesting a RMA for defective goods:

1. If any warranty issues occur, simply contact the UPI for RMA number. To make it easy for you we have three acceptable methods for requesting the RMA.

- Dealer Portal
- Email: returns@upauto.com
- Fax : (888) 986-5988

Note: To ensure you receive a timely RMA credit, we cannot accept RMA requests by phone.

2. You will be required to provide the following information:
 - Your business name
 - Contact name and telephone number (in case we have questions)
 - A list of the defective item number and quantity with the nature/ reason of the defect
 - Special instructions you have for us
 - The enclosed fax form may be used for your convenience to request an RMA
3. UPI will review the request to ensure the products are within the stated warranty period.
4. Once we have validated the warranty items, a RMA confirmation, listing the items and cost will be faxed to the customer within 3 business days. UPI will process the credit to your account within 30 days.

RETURNS / CATALOGS / DISCLAIMER

IMPORTANT: PLEASE REVIEW CAREFULLY

Note: The majority of time there will be no need to return the warranty product to us. However, from time to time, UPI may require some warranty products to be shipped back so we may analyze the cause of the failure. All warranty products that are required to be shipped back will be freight prepaid by UPI.

Stock Return

United Pacific Industries encourages all customers to regularly monitor the sales volume and stock level of their inventory items. As sales trends may slow the movement of specific items, our hope is that those items are featured as "close-out specials" as to minimize stock returns. We also understand that the customer, from time to time, may accumulate over-stock items and desire to return those. Therefore, we have adopted the following policy below.

NOTE:

Items must have been purchased by the dealer requesting the stock return.

Items must have been purchased within the preceding 12 months.

Items that have been discontinued will not be considered for return.

1. Contact the United Pacific for RMA number. We have 3 acceptable methods for requesting the RMA:

- Dealer Portal Dashboard
- Email: returns@upauto.com
- Fax : (888) 986-5988

Note: To ensure you receive a timely RMA credit, we cannot accept RMA requests by phone.

2. You will be required to provide the following information:

- Your business name
- Contact name and telephone number (in case we have questions)
- A list of the defective item number and quantity with the nature/ reason of the defect
- Special instructions you have for us

3. Your claim will be reviewed within 5 business days and you will be contacted by your sales representative who will discuss solutions to liquidate these slow moving items.

4. In the event United Pacific and the customer agree to a credit in lieu of returning the items, this credit will be issued within 10 business days.

5. In the event items are returned by the customer, United Pacific will issue an RMA number to the customer. In issuing the RMA approval, the following conditions will apply:

- Returned items are subject to a 20% re-stocking fee.
- Return shipping costs are the responsibility of the customer.
- Items must not have any retail/price sticker on exterior packaging or they will be returned to the customer at customer's expense and no credit given.
- Items must be in good condition with original packaging intact or they will be returned to the customer at customer's expense and no credit given.
- Allow up to 30 days for the credit to be issued from the time the returned items are received.

6. Stock returns may be requested throughout the year and are subject to final approval by United Pacific.

Closeout / Discontinue

UPI will not warranty or accept returns on Closeout/Discontinue items

Procedure:

An inventory of the merchandise being returned must accompany each return. The RMA number should be prominently displayed on each carton/box

All Returns must be returned freight prepaid.

Ship Returns to:
United Pacific Industries
Attn: Returns Department
3788 E. Conant St.
Long Beach, CA 90808

RMA:

Outstanding RMA's will be automatically cancelled if not used within 30 days of issuance. Go to the Dealer Portal Guide Page for more information on RMA procedure.

Disclaimer

United Pacific Industries reserves the right to amend or update our Policies & Procedures without notice.

United Pacific Industries is not responsible for typographical, product information or print errors. Specifications on this catalog may be changed without advance notice. Products may look different from those in the photos on this catalog due to printing quality.

United Pacific		DEFECTIVE GOODS / WARRANTY CLAIM FORM	
		Date:	_____
3788 E. CONANT STREET		Company Name:	_____
LONG BEACH, CA 90808		Address:	_____
TEL: (562) 421-3888		City, State, Zip:	_____
FAX: (888) 986-5988		Contact Name:	_____
TOLL FREE: (800) 793-6988		Phone Number:	_____
UPAuto.com		Fax Number:	_____
		Email:	_____

List defective items below:

Item#	Qty	Description	Reason for Defect	Date Sold to Customer

Any special notes / instructions for United Pacific (list here)

File your claim at:
By email - sales@upauto.com
By fax - (888) 986-5988

Internal Use Only	
Date Received: _____	Final RMA: _____
RMA Approval Date: _____	Credit Amount: _____
RMA Number: _____	Approved by: _____

CALIFORNIA PROPOSITION 65 WARNING



WARNING: Cancer & Reproductive Harm-
www.P65Warnings.ca.gov

PRODUCT INDEX

ITEM#	PAGE#	ITEM#	PAGE#	ITEM#	PAGE#	ITEM#	PAGE#	ITEM#	PAGE#
10007	19	32814	25	36820	22	60054	25	20847M5	41
10013	15	32898	32	38922	40	60055	25	22941B	28
10045	33	32899	32	39161	30	60056	25	22942B	28
10046	33	34131	24	39162	30	70106	18	22943B	28
10047	31	34131	37	39163	30	70369	7	36515B	15
10049	26	34132	24	39164	30	70612	9	36743B	30
10057	42	34132	37	39165	30	70613	9	36744B	30
10059	26	34133	24	39212	40	70788	15	36745B	30
10060	19	34133	37	39565	36	70789	15	38170CB	22
10064	26	34134	24	39566	36	70790	15	38171CB	22
10070	42	34134	37	39909	12	70791	15	38362CB	22
10084	33	34135	37	40946	29	70792	27	38363CB	22
10117	38	34136	37	40970	43	70793	27	38922B	40
10326	20	34137	37	40971	43	70794	27	39311B	6
10337	5	34138	37	41069	43	70795	27	39312B	6
10341	8	35765	32	41451	44	70796	27	39313B	6
10342	5	35766	32	41452	35	70797	27	70601B	35
10342	8	35767	32	41775	4	72003	39	70622B	35
10347	38	35768	32	41776	4	72046	7	70644B	35
10348	33	35769	21	41777	4	72047	7	70645B	35
10348	38	35770	21	41778	4	72053	30	A1060-4	39
10569	13	35771	21	41779	4	72053	39	UCSW01	14
10570	13	35772	21	41780	4	80000	10	UF1219	14
10588	9	35773	21	41781	4	80001	10		
10770	27	35774	21	41782	4	80002	10		
10780	43	35775	13	41783	4	80003	10		
11016	27	35776	13	41784	4	80004	10		
11017	27	35779	11	41785	4	80005	10		
11018	27	35780	11	41786	4	90023	44		
11019	27	35781	11	42309	35	90066	44		
20531	31	35782	11	42439	9	90089	44		
21149	42	35819	3	42445	12	95002	20		
21150	42	35820	3	42446	12	98989	29		
21335	11	35821	3	42447	12	98990	23		
21821	39	35822	3	42486	9	98991	23		
21822	34	35823	3	42487	9	98992	23		
21943	34	35824	3	42489	25	98993	29		
21944	34	35825	3	42490	25	99018	23		
21945	41	35826	3	42491	25	99036	17		
21946	41	35829	7	42492	25	99060	23		
21947	41	35830	7	42493	25	99074	36		
21948	41	36002	6	42494	25	99086	29		
21949	41	36003	6	42495	25	99193	12		
21950	41	36446	19	42496	25	99194	12		
23496	14	36447	19	42825	31	99195	12		
23497	14	36448	19	42826	31	99196	17		
23498	14	36452	14	42844	38	99198	19		
23499	14	36454	5	42845	38	99199	16		
23766	28	36455	5	42846	38	99200	16		
23767	28	36456	5	42847	38	99201	17		
23768	28	36457	5	42848	31	99206	44		
23769	28	36515	15	42849	31	110861	9		
23770	28	36560	22	42851	34	110862	9		
23771	28	36561	22	42852	34	110863	12		
23772	28	36562	22	42853	34	110864	12		
23773	28	36563	22	42854	34	10000CB	11		
23774	28	36747	13	42855	39	10553CB	7		
30419	25	36748	13	46126	44	10554CB	5		
30614	35	36815	24	46174	39	10562CB	8		
31050	22	36816	24	48156	35	10564CB	4		
32598	32	36817	24	48157	35	10583CB	8		
32599	32	36818	24	52009	36	10778CB	4		
32813	25	36819	22	52010	36	10781CB	8		



United Pacific

UPauto.com | T 800.790.6988 | F 888.986.5988

© 2021 United Pacific Industries. All Rights Reserved. Products not shown to scale. Specifications subject to change without notice.

UF1220

2020 Truck New Item Flyer Collection



710270061976